

TQHA Show Committee presents



April 30-May 4, 2025

Tennessee Miller Coliseum
Murfreesboro, Tennessee

Where good horses come to compete

PATTERN BOOK

Thank You to our Sponsors

Gold Level Sponsors



Silver Sponsors



Award Sponsors



Hospitality Sponsors



LUCKY 7 CLASSIC
Working Hunter Over Fences Classes
Wednesday April 30

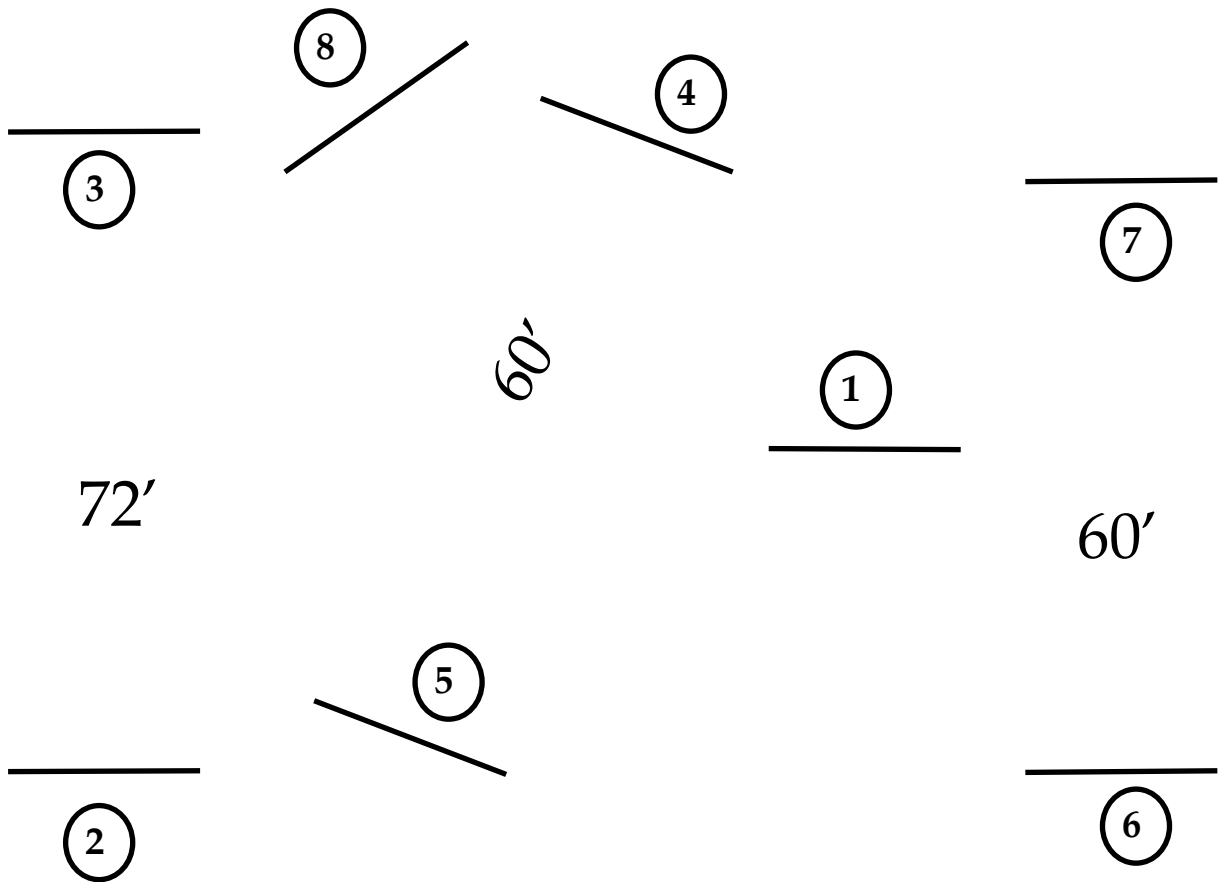

GATE

LUCKY 7 CLASSIC
Equitation Over Fences Classes
Wednesday April 30

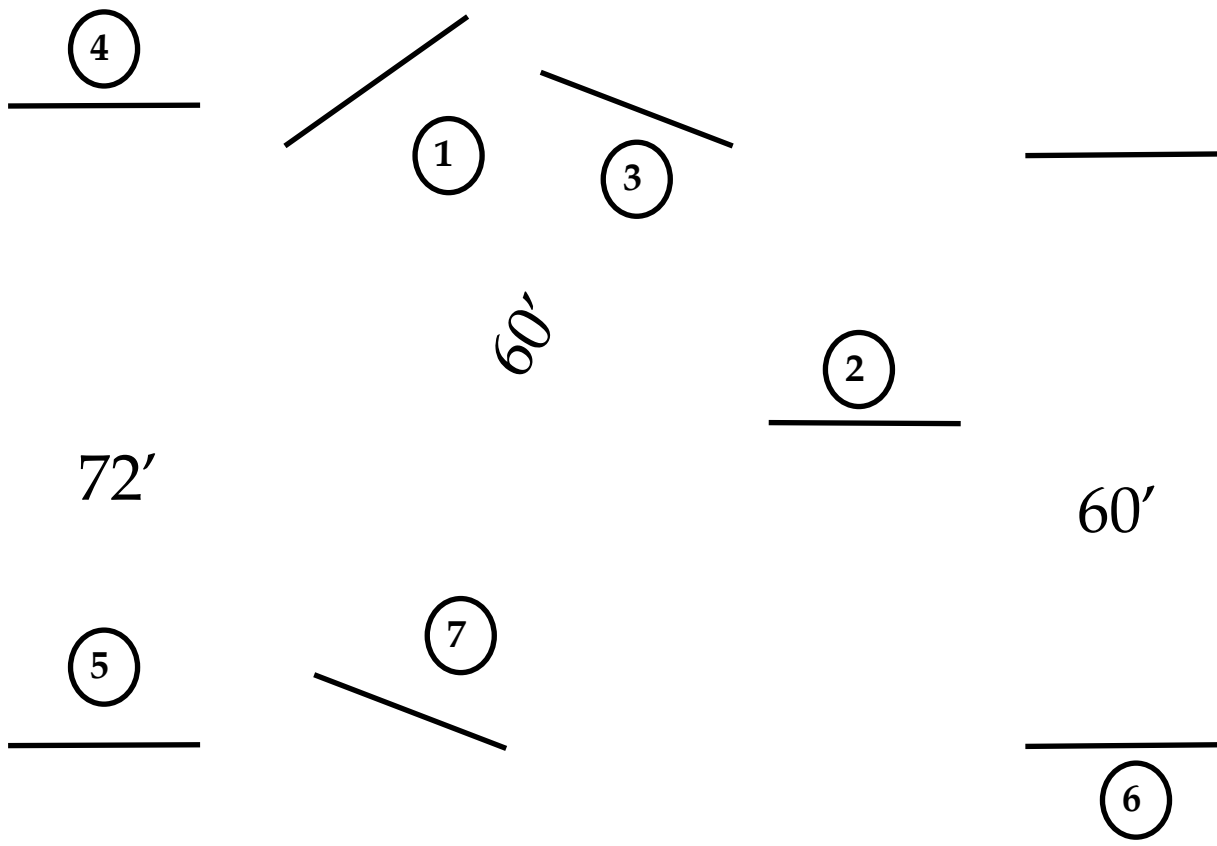

GATE

LUCKY 7 CLASSIC

Jumping Classes
Wednesday April 30
Jump Off: 2,3,4,6,7,8

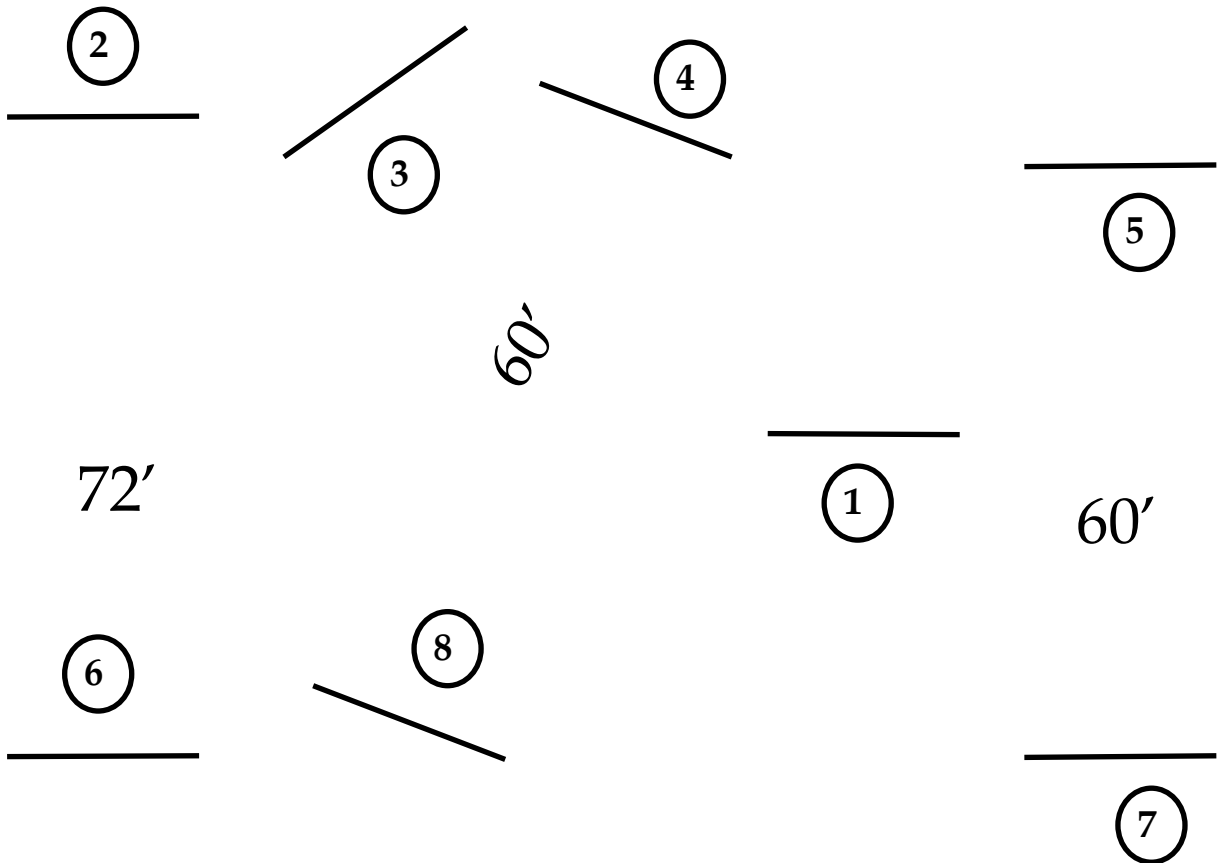

GATE

LUCKY 7 CLASSIC

Hunter Hack Classes

Wednesday April 30

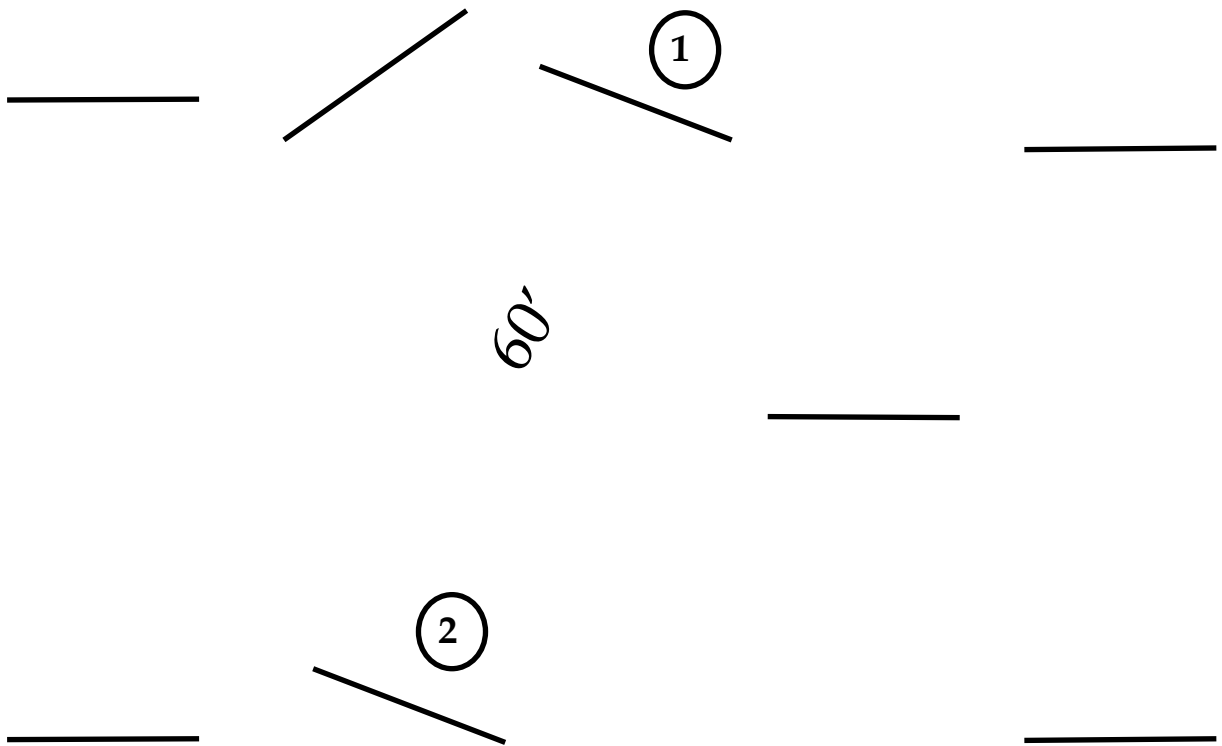

GATE

LUCKY 7 Classic– Murfreesboro, TN

Show Date: April 30, 2025

EQUITATION

Small Fry

L1 Y WT

L1 Am W/T

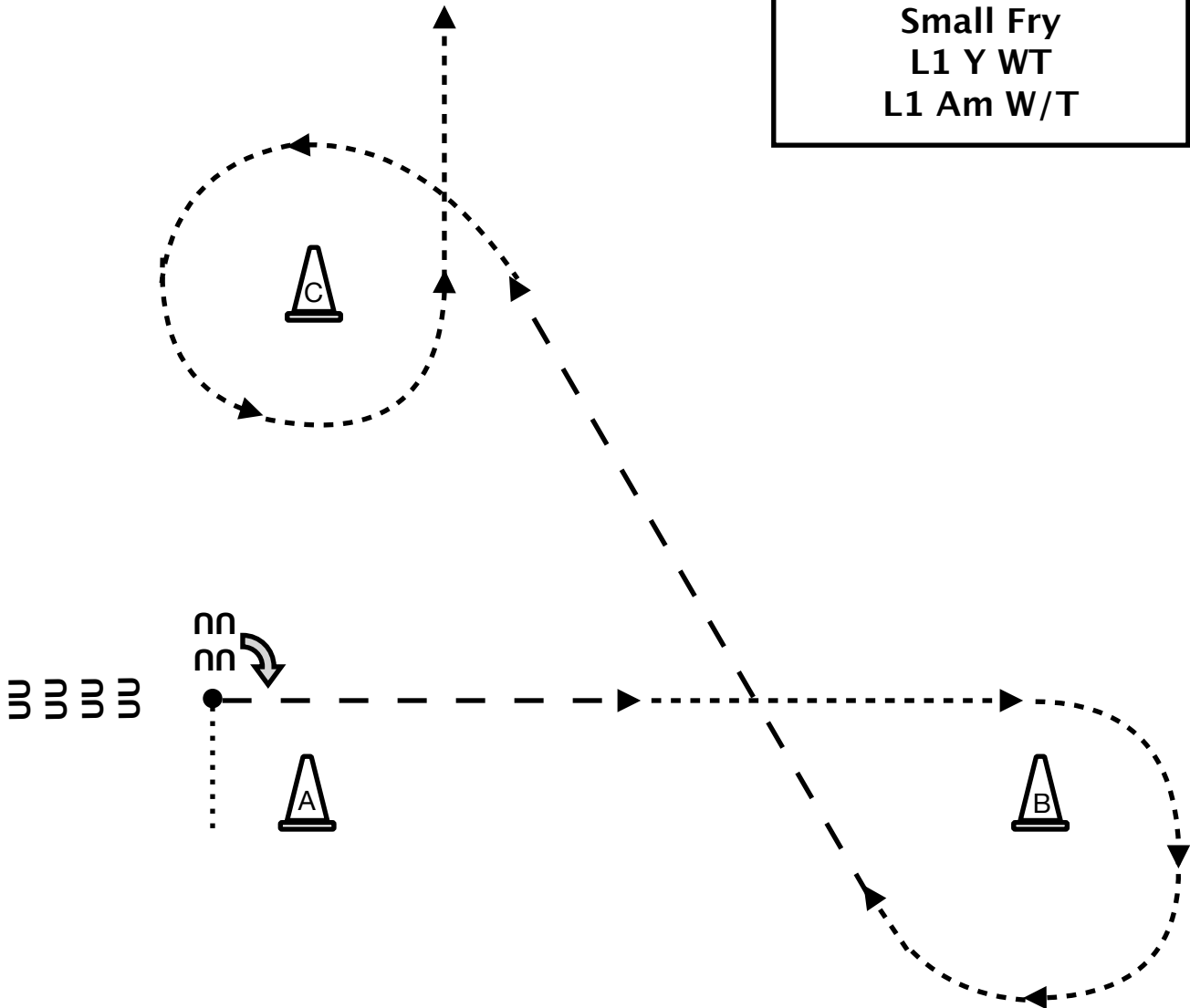

1. Begin at cone A. Walk forward. Perform a 90° on the Haunches to the Right.
2. Back.
3. Sitting Trot halfway from A to B.
4. Posting Trot Left Diagonal to and around B.
5. Sitting Trot to C.
6. Trot on Right Diagonal to End Pattern.

DESIGNED BY
Christie

Walk
Sitting Trot	— —
Posting Trot
Canter	————
Back	← U U U U

LUCKY 7 Classic- Murfreesboro, TN

Show Date: April 30, 2025

EQUITATION
Y 14-18
Amateur
Am Select

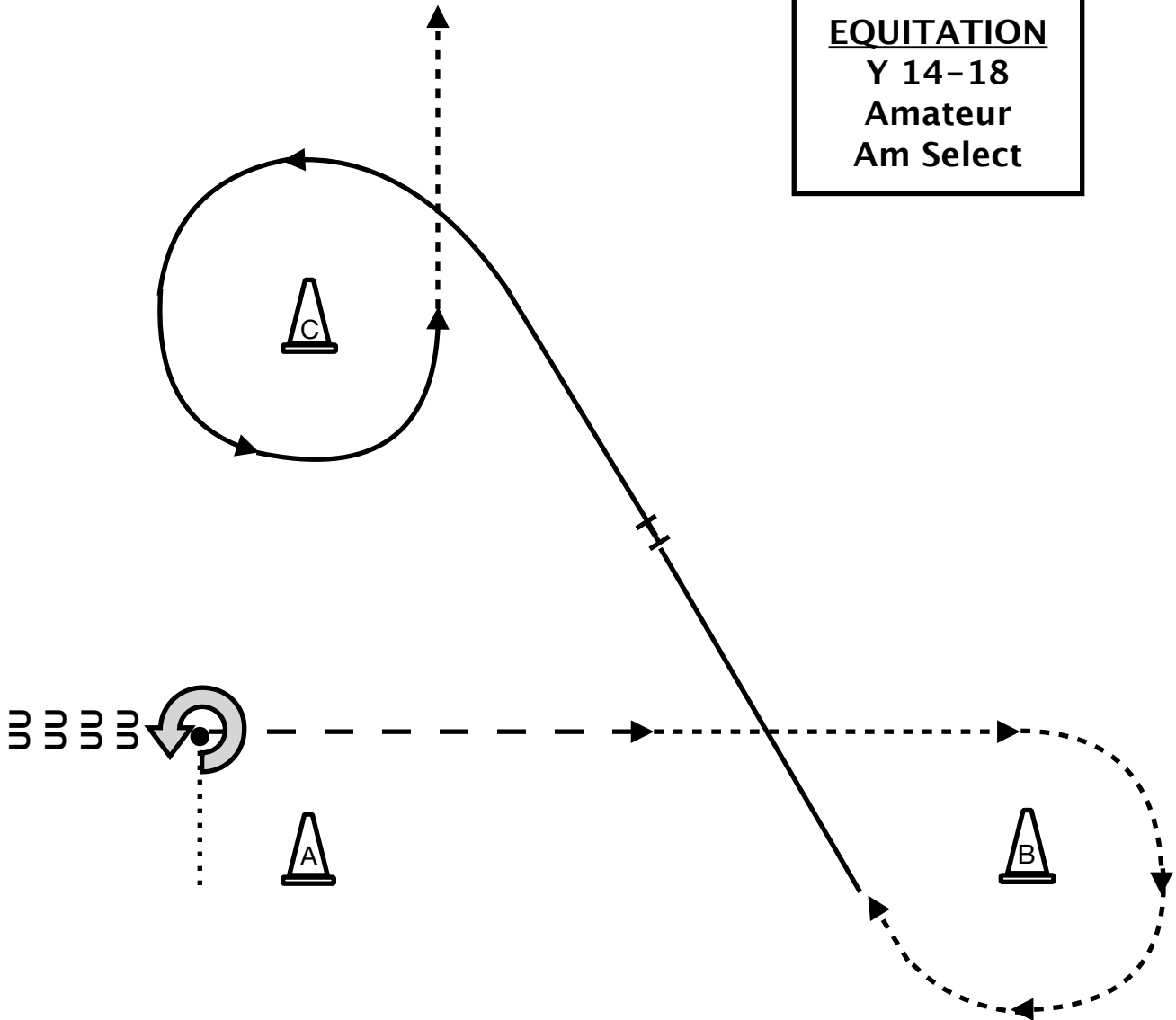

1. Begin at cone A. Walk forward. Stop. Execute a 270° turn on the Forehand to the Left.
2. Back.
3. Sitting Trot halfway from A to B.
4. Posting Trot Left Diagonal to and around B.
5. Canter on Right Lead from B halfway to C.
6. Change Leads.
7. Canter Left Lead around C.
8. Trot on Right Diagonal to End Pattern.



Walk
Sitting Trot	— — — —
Posting Trot
Canter	—————
Back	← 3 3 3 3
Change leads	I

LUCKY 7 Classic- Murfreesboro, TN

Show Date: April 30, 2025

EQUITATION

L1 Youth

L1 Amateur

Y 13&u

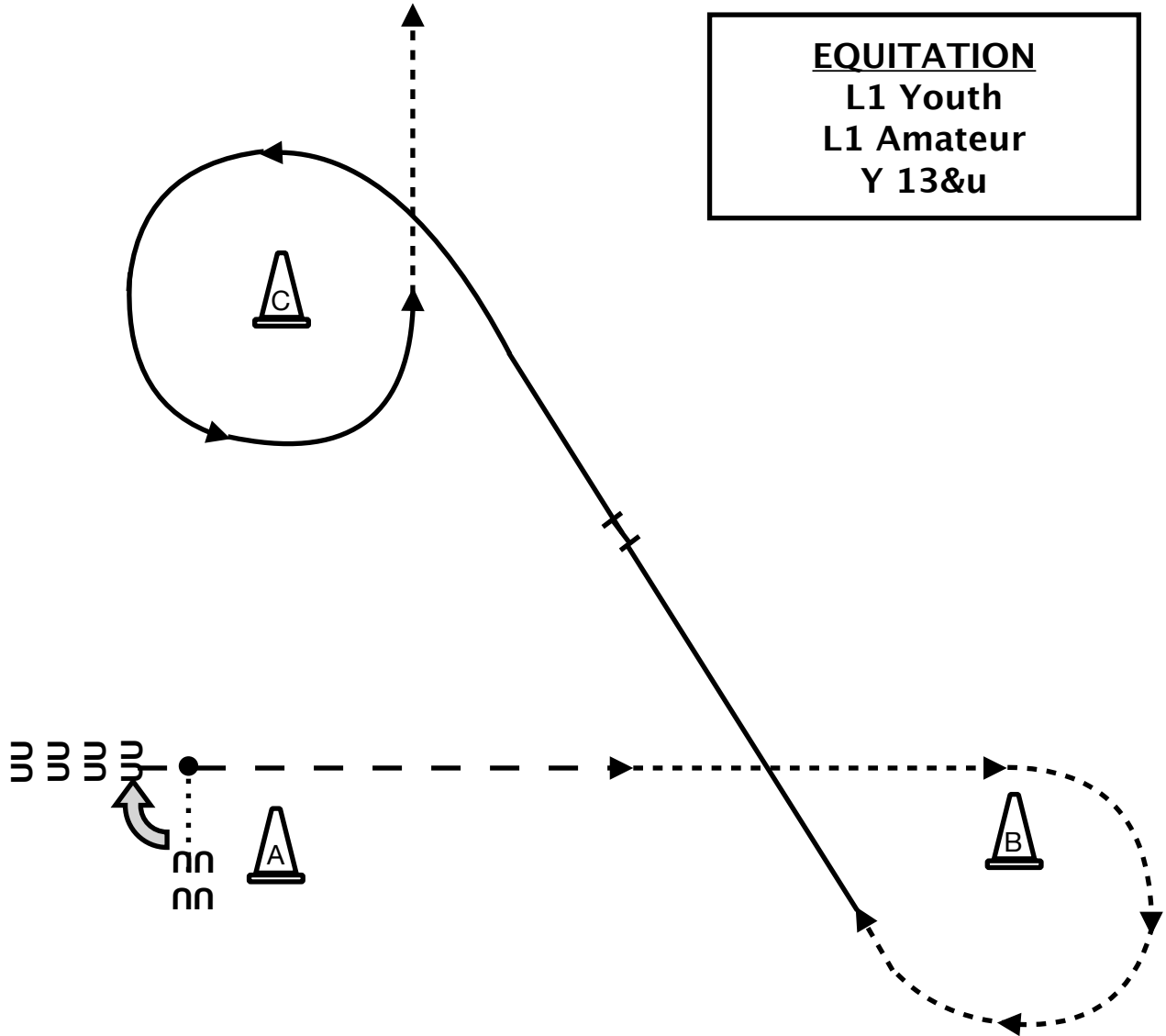

1. Begin at cone A. Walk forward. Execute a 90° turn on the Forehand to the Right.
2. Back.
3. Sitting Trot halfway from A to B.
4. Posting Trot Left Diagonal to and around B.
5. Canter on Right Lead halfway to C.
6. Change Leads.
7. Canter Left Lead to and around C.
8. Trot on Right Diagonal to End Pattern.



Walk
Sitting Trot	— — — —
Posting Trot	- - - - -
Canter	—————
Back	← 3 3 3 3
Change Leads	I

Lucky 7 Circuit All Level 1 and youth Ranch Trail 05/01/2025

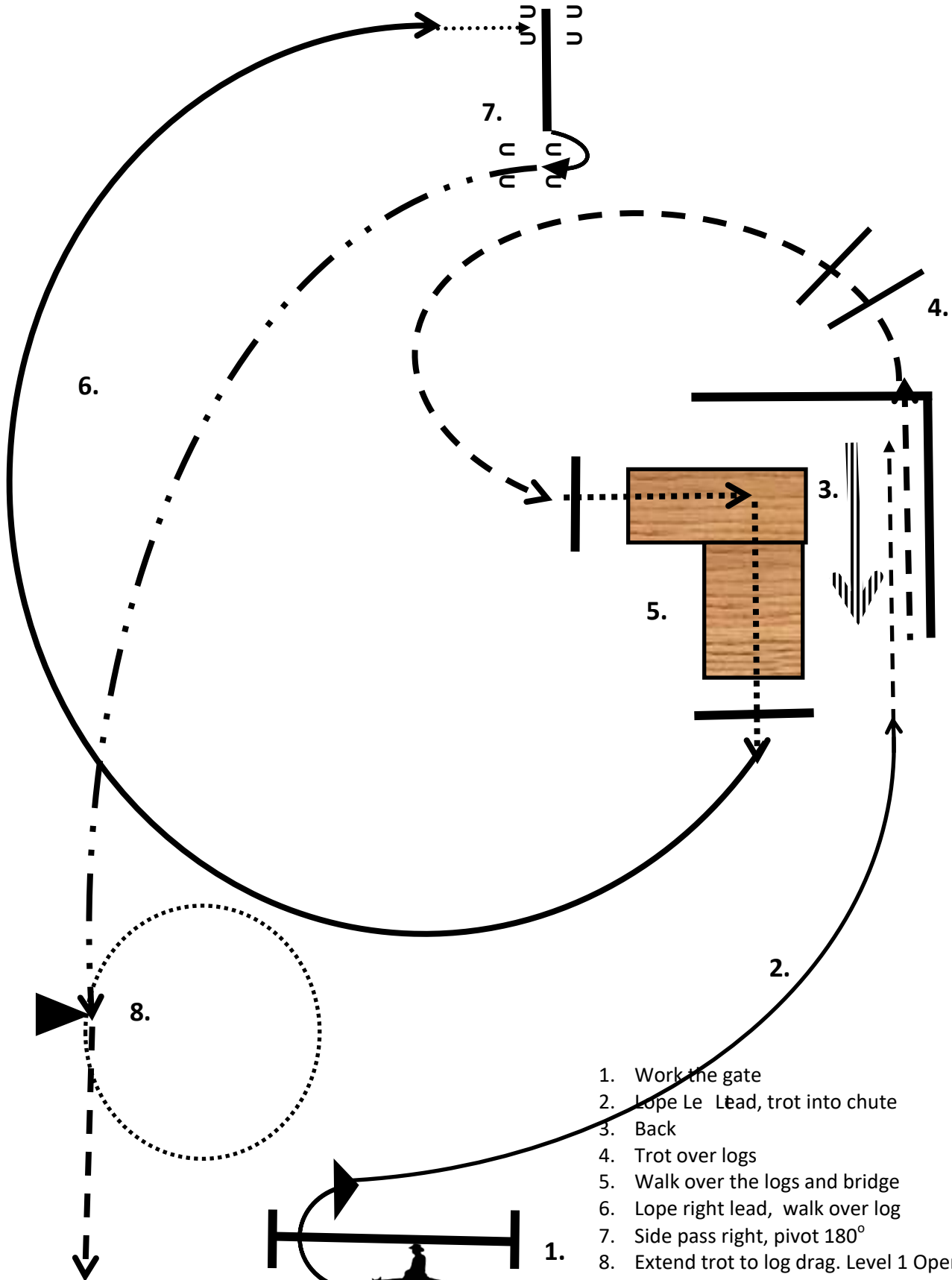

1. Work the gate
2. Lope Left Lead, trot into chute
3. Back
4. Trot over logs
5. Walk over the logs and bridge
6. Lope right lead, walk over log
7. Side pass right, pivot 180°
8. Extend trot to log drag. Level 1 Open drag the log. Level 1 youth and amateur Pick up rope and walk or trot circle replace rope, Do NOT DRAG, trot to exit



Patrick Kayser design, 2024

Lucky 7 Classic Circuit Amateur, Open Ranch Trail 05/01/2025

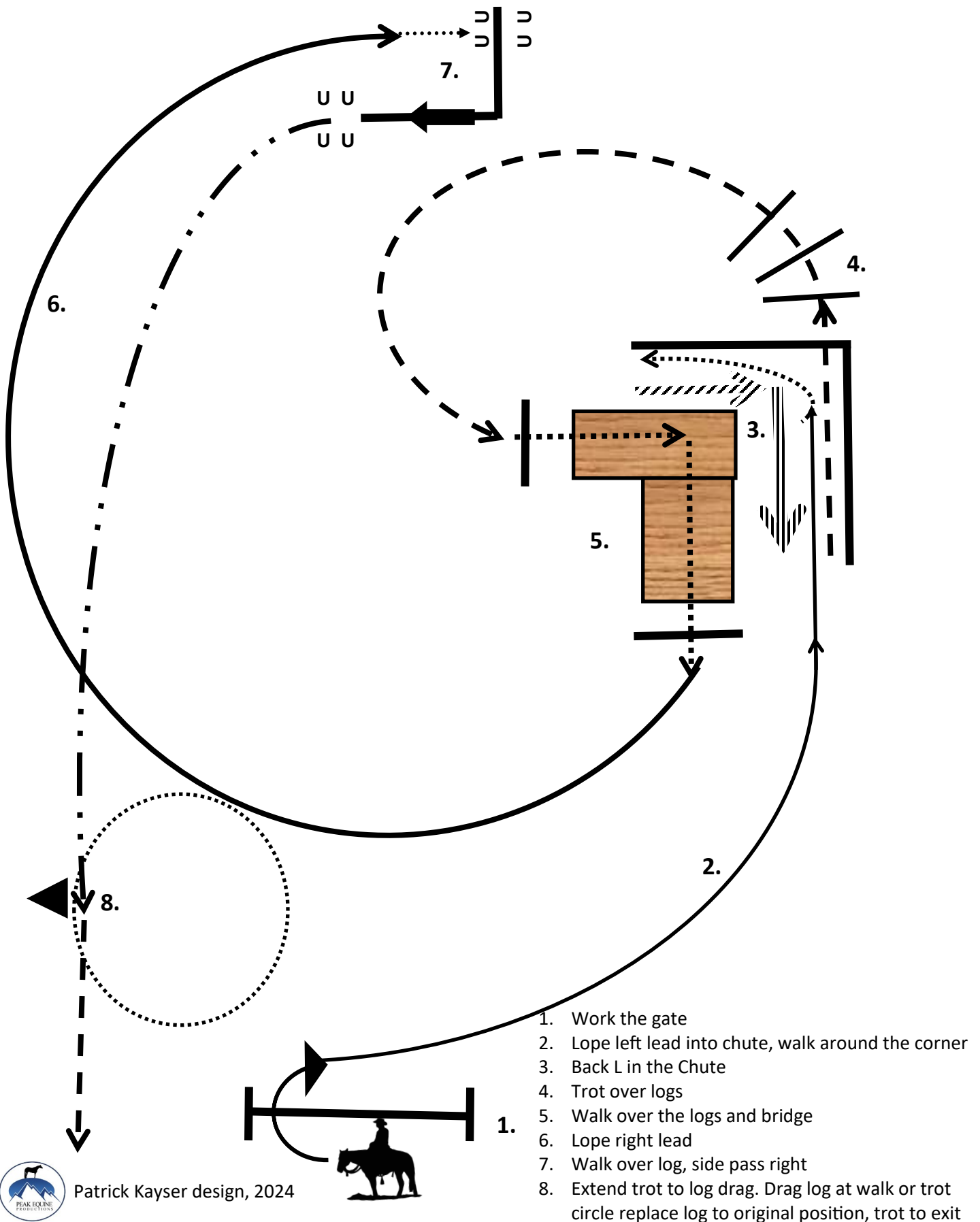

Patrick Kayser design, 2024

LUCKY 7 CLASSIC – Murfreesboro, TN

Small Fry – Yth W/T L1 – Am W/T L1

May 1, 2025

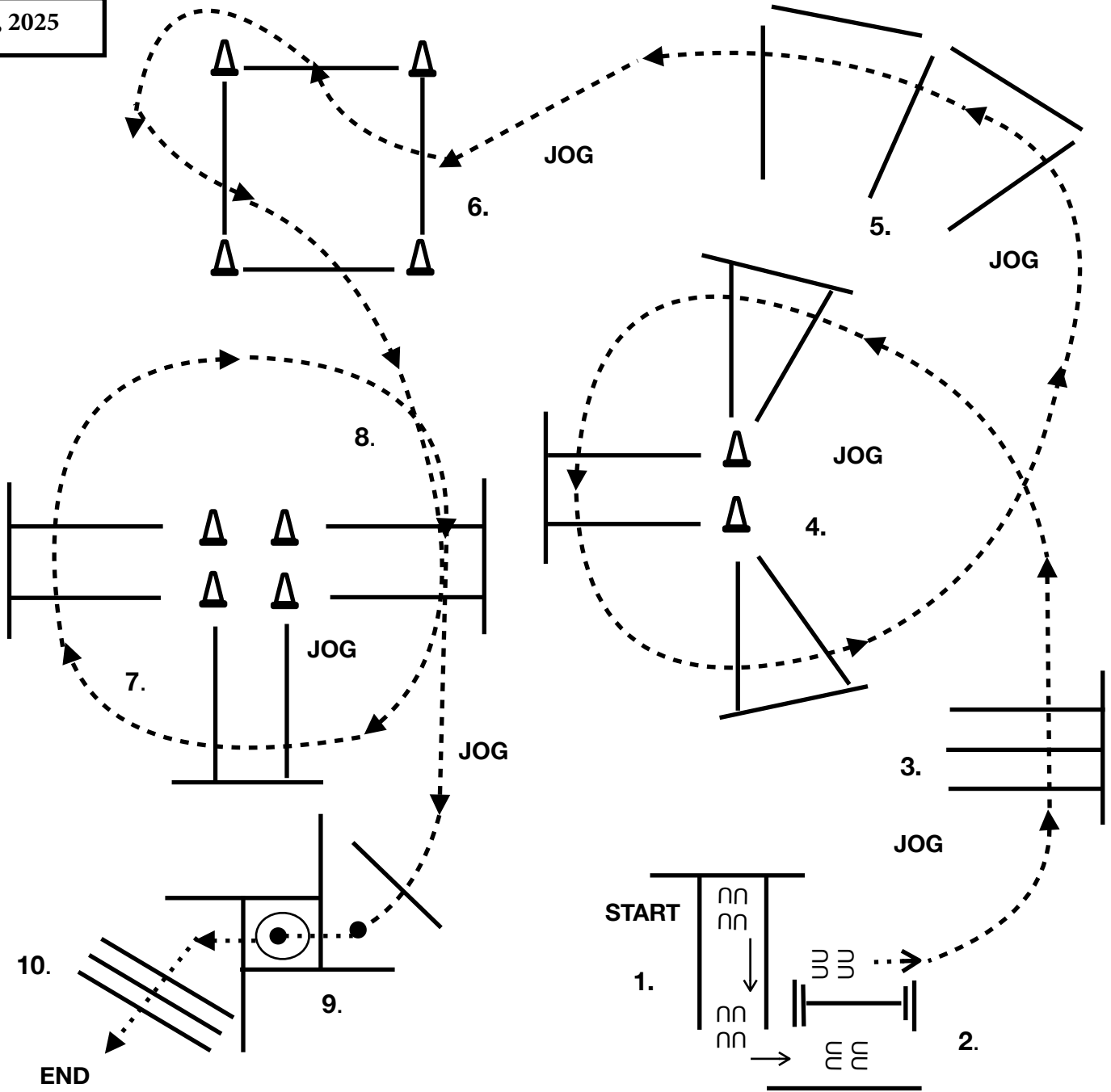

1. Begin in Chute. Back out of the Chute, around to the Gate.
2. Work Right Hand Gate. Open Gate. Walk over Pole. Close Gate.
3. You may Walk forward. Jog over poles.
4. Jog over poles.
5. Jog over poles.
6. Jog over poles as shown.
7. Jog over 6 poles.
8. Jog over 3 poles into first box. Stop.
9. Walk into box. Turn 360° either direction. Walk out of box.
10. Walk over poles to End Pattern.



WALK
JOG	-----
LOPE	_____

LUCKY 7 CLASSIC - Murfreesboro, TN

ALL TRAIL (except Small Fry - W/T)

May 1, 2025

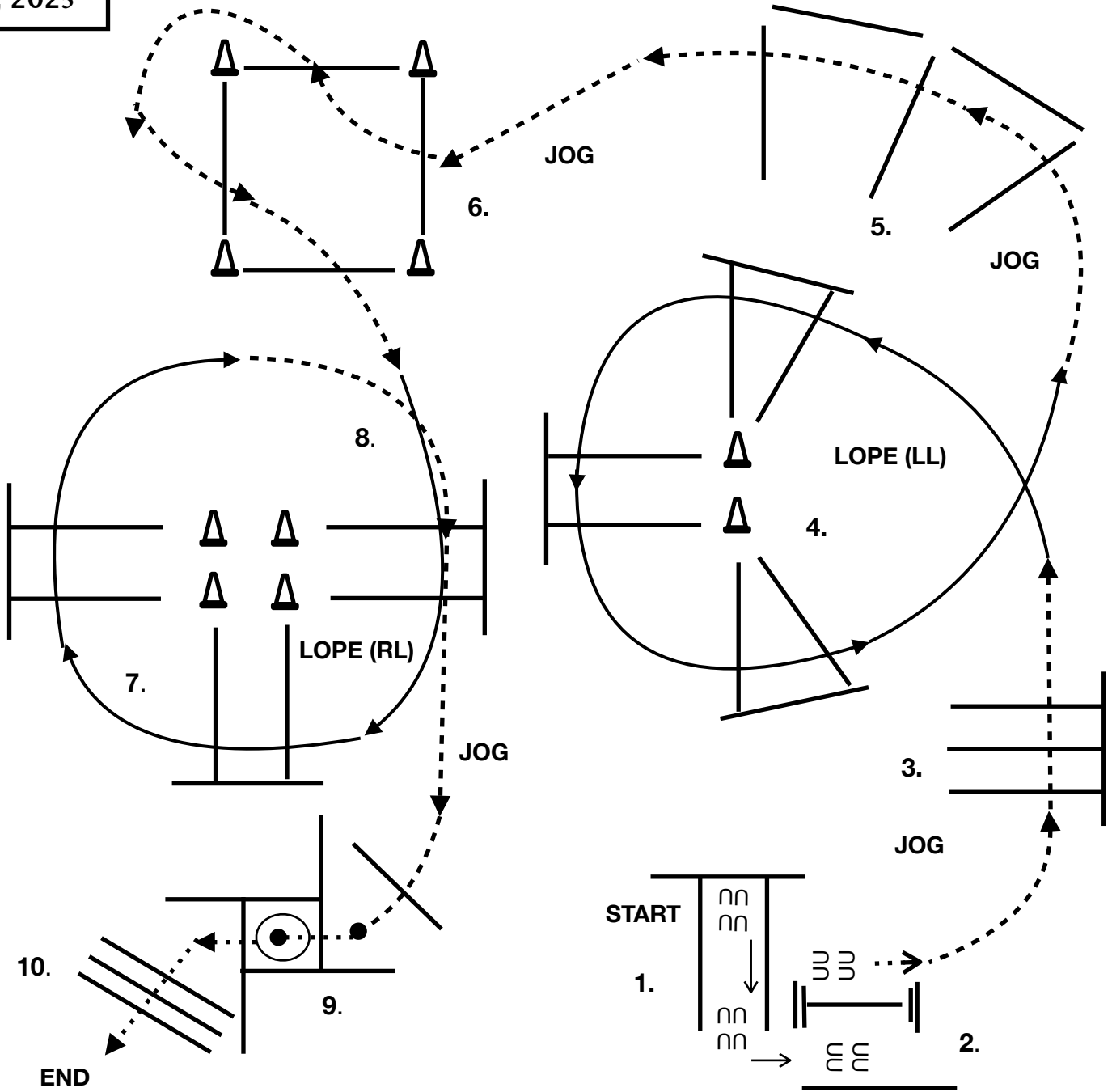

1. Begin in Chute. Back out of the Chute, around to the Gate.
2. Work Right Hand Gate. Open Gate. Walk over Pole. Close Gate.
3. You may Walk forward. Jog over poles.
4. Lope Left Lead over poles.
5. Jog over poles.
6. Jog over poles as shown.
7. Lope Right Lead over poles.
8. Jog over poles into first box. Stop.
9. Walk into box. Turn 360° either direction. Walk out of box.
10. Walk over poles to End Pattern.



WALK
JOG	-----
LOPE	_____

LEVEL I WESTERN RIDING PATTERN 2- May 1

LEGEND

.....	Walk
- - -	Jog
————	Lope
//////	Back
■	Lead Changing Area

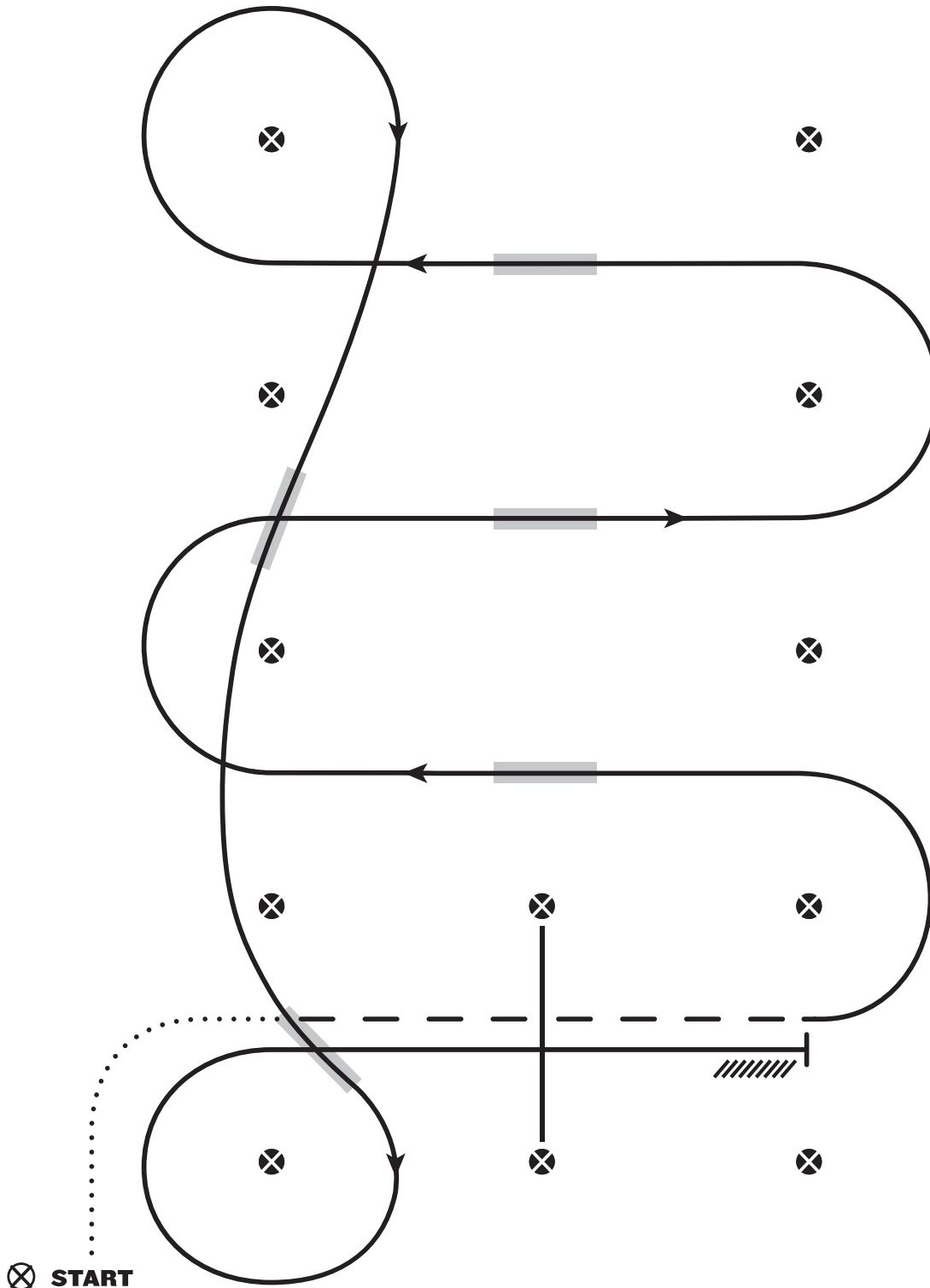

1. Walk at least 15 feet from start cone to the first marker, as drawn, transition to jog, jog over log.
2. Transition to the lope left lead
3. First crossing change
4. Second crossing change
5. Third crossing change
6. Circle & first line change
7. Second line change & circle
8. Lope over log
9. Stop & back

ALL WESTERN RIDING - PATTERN 2-May 1

LEGEND

.....	Walk
- - -	Jog
————	Lope
///////	Back
■	Lead Changing Area

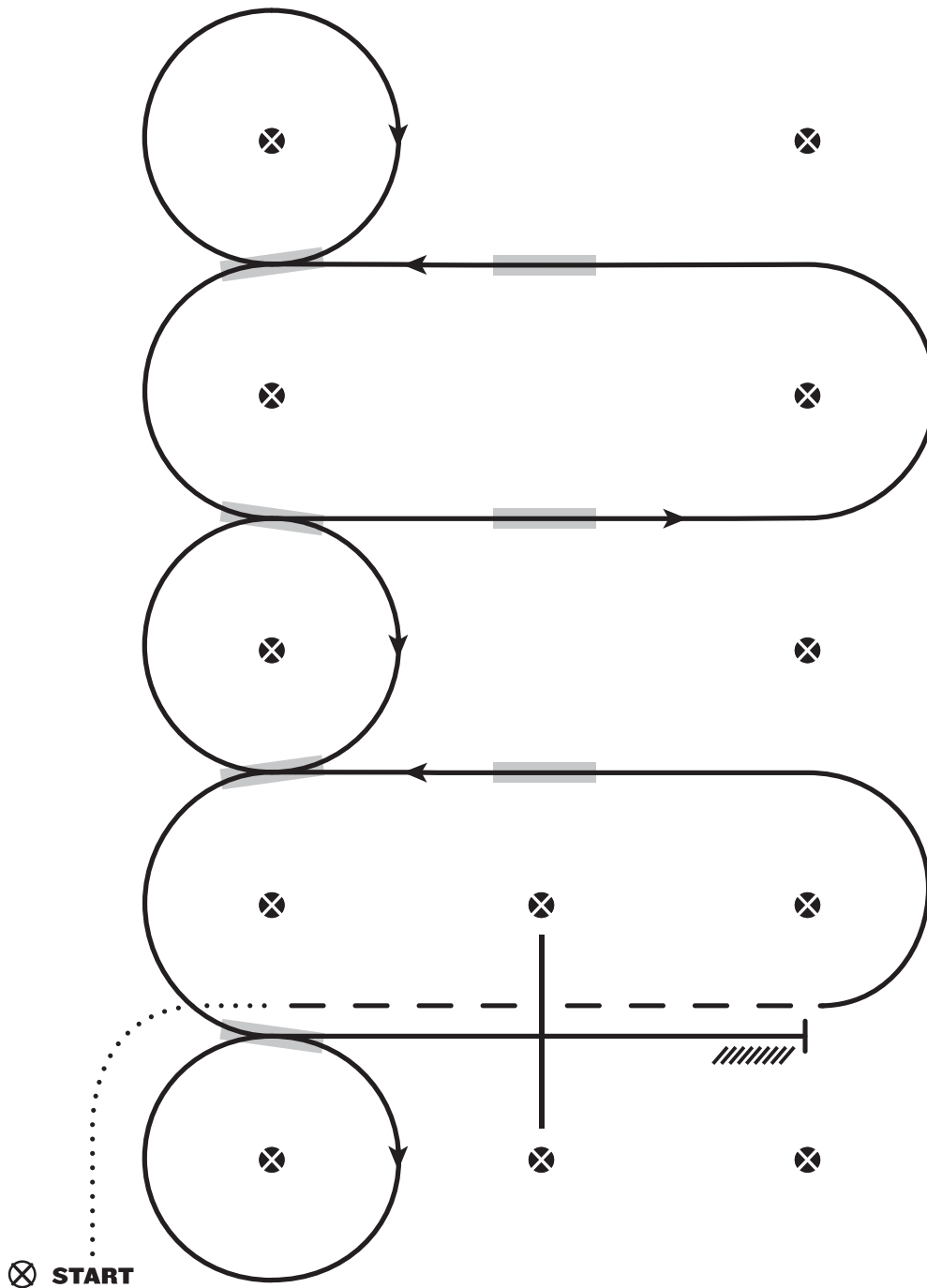

1. Walk at least 15 feet from start cone to the first marker, as drawn, transition to jog, jog over log.
2. Transition to the lope left lead
3. First crossing change
4. Second crossing change
5. Third crossing change
6. Circle & first line change
7. Second line change
8. Third line change
9. Fourth line change & circle
10. Lope over log
11. Lope, stop & back

All RANCH RIDING - PATTERN 6 May 1

LEGEND

.....	Walk
....	Extended Walk
- - -	Trot
- - - -	Extended Trot
— — —	Lope
— — — —	Extended Lope
////	Back
\\	Lead Change

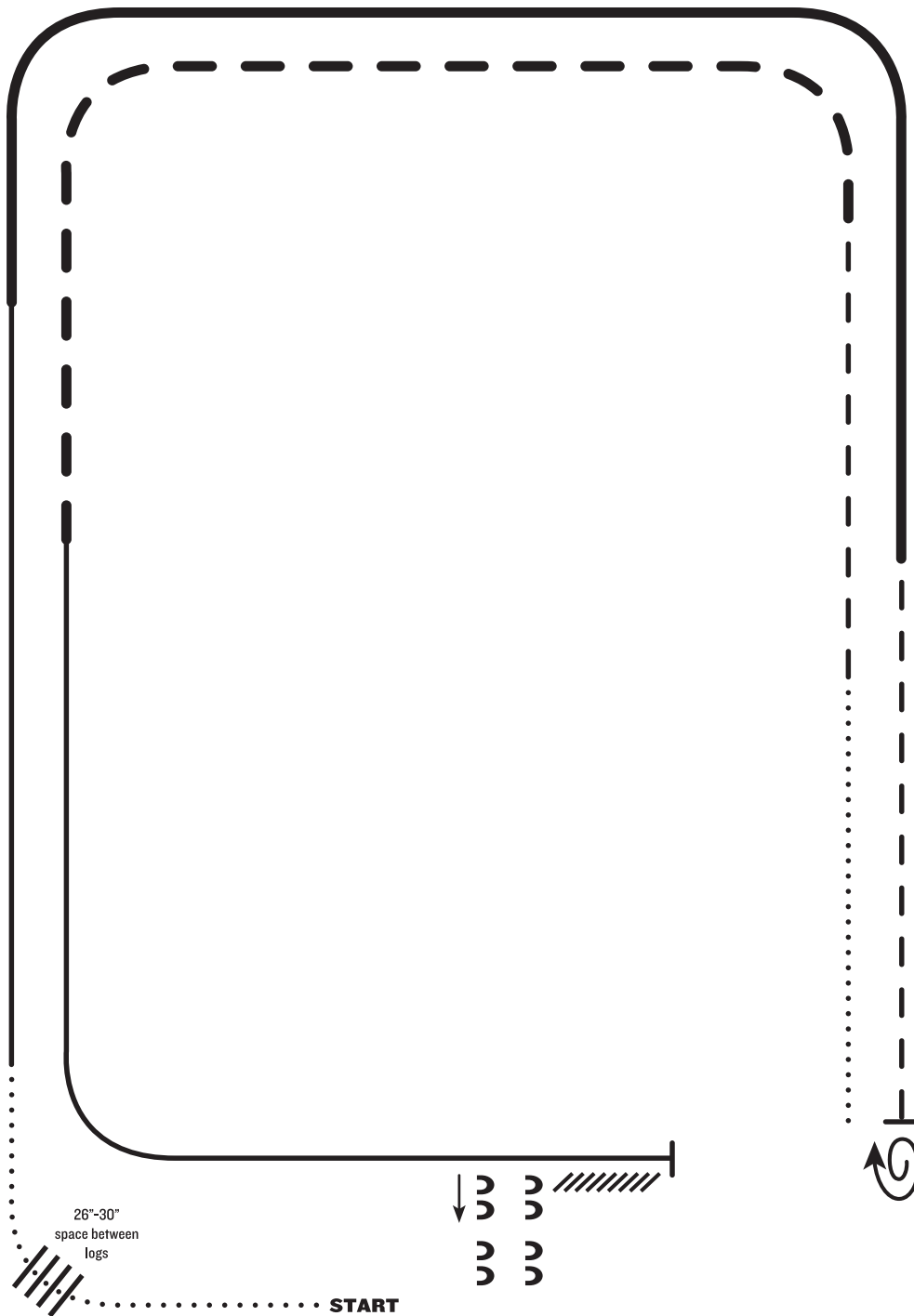

1. Walk
2. Walk over logs
3. Lope right lead
4. Extended lope right lead
5. Trot
6. Stop, 1/2 turn right
7. Walk
8. Trot
9. Extended trot
10. Lope left lead
11. Stop and back
12. Side pass right

Note: The drawn description of this pattern is only intended for the general depiction of the pattern. Exhibitors should utilize the arena space to best exhibit their horses.

All REINING PATTERN 2- May 1

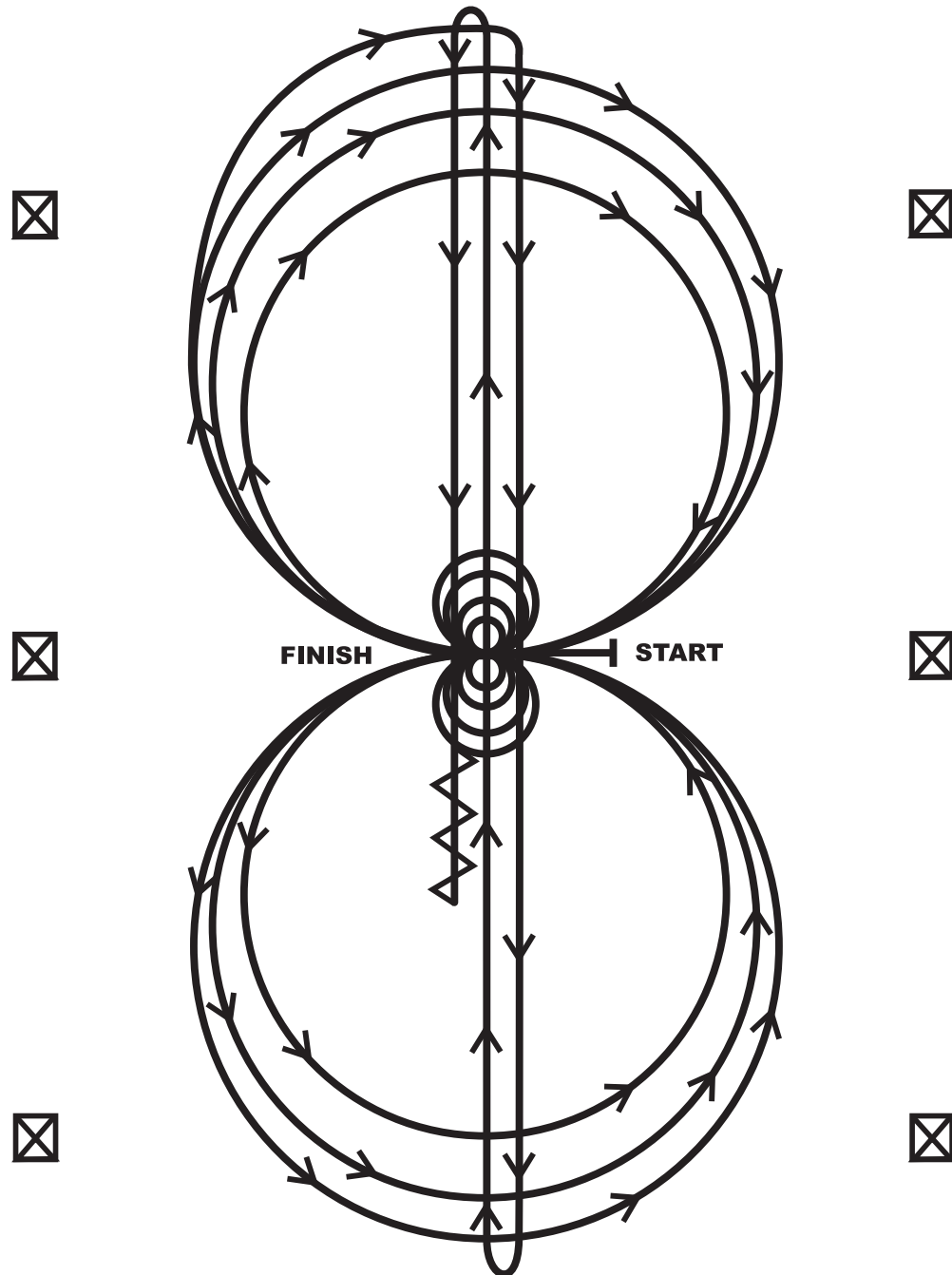

Horses may walk or jog to the center of arena. Horses must walk or stop prior to starting pattern. Beginning at the center of the arena facing the left wall or fence.

1. Beginning on the right lead, complete three circles to the right: the first circle small and slow; the next two circles large and fast. Change leads at the center of the arena.
2. Complete three circles to the left: the first circle small and slow; the next two circles large and fast. Change leads at the center of the arena.
3. Continue around previous circle to the right. At the top of the circle, run down the middle to the far end of the arena past the end marker and do a right rollback—no hesitation.
4. Run up the middle to the opposite end of the arena past the end marker and do a left rollback—no hesitation.
5. Run past the center marker and do a sliding stop. Back up to the center of the arena or at least ten feet (three meters). Hesitate.
6. Complete four spins to the right. Hesitate.
7. Complete four spins to the left. Hesitate to demonstrate the completion of the pattern.

LUCKY 7 CLASSIC – Murfreesboro, TN

Show Date: May 2, 2025

SHOWMANSHIP

L1 Youth / L1 Amateur / Youth 13&u

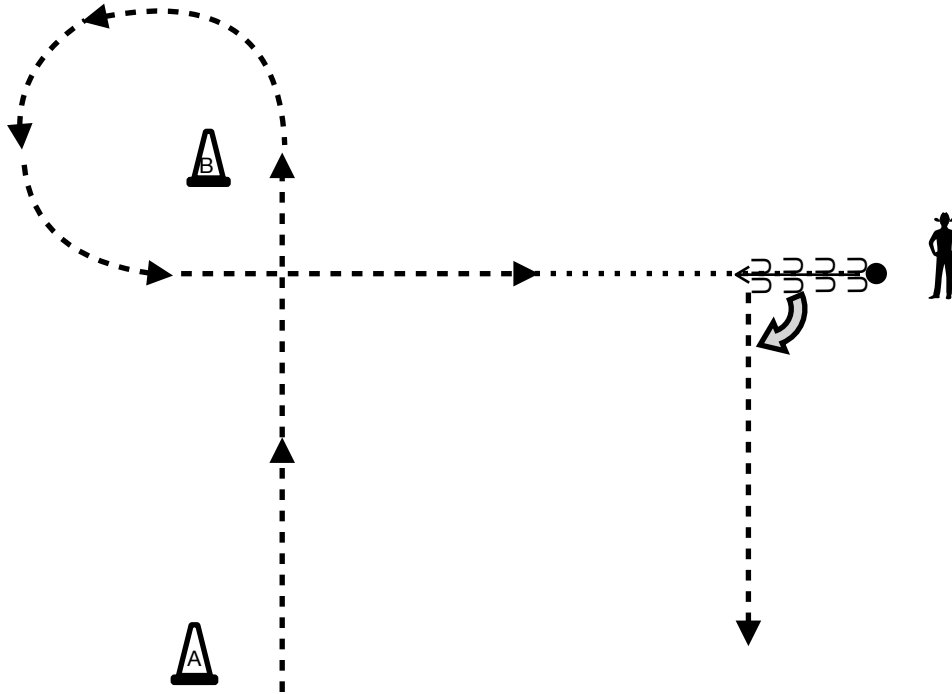

1. Be Ready at Cone A. Trot to & around B & halfway to the judge.
2. Walk to the judge.
3. Stop & Set up.
4. Inspection.
5. When dismissed, back one horse length.
6. Perform a 90° turn.
7. Trot away.



Walk
Trot	-----
Back	←3333

LUCKY 7 CLASSIC – Murfreesboro, TN

Show Date: May 2, 2025

SHOWMANSHIP Small Fry

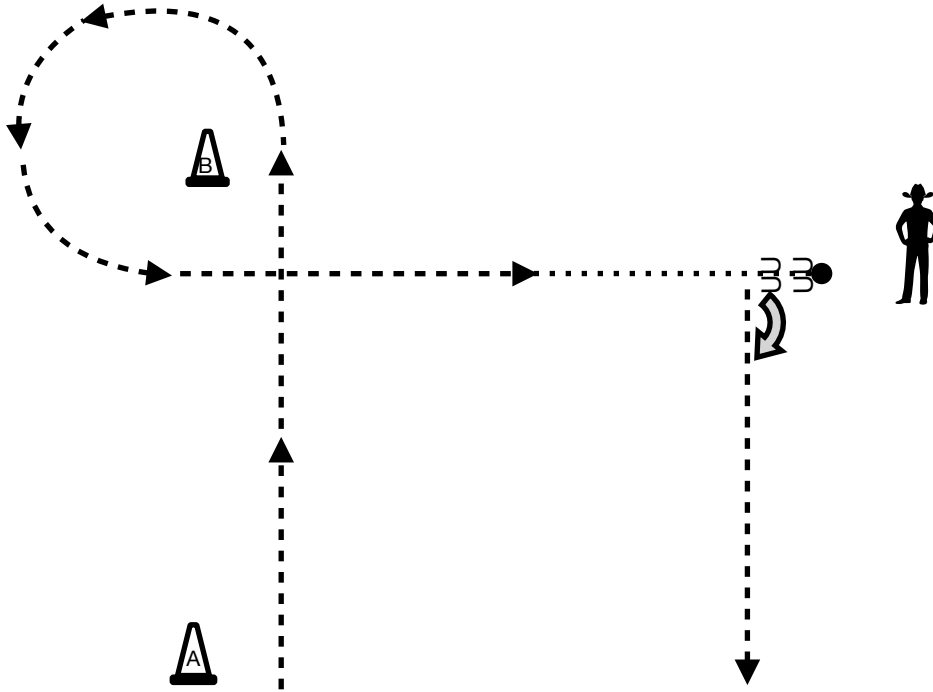

1. Be Ready at Cone A. Trot to & around B & halfway to the judge.
2. Walk to the judge.
3. Stop & Set up.
4. Inspection.
5. Perform a 90° turn.
6. Trot away.

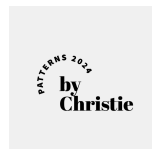

Walk
Trot	-----
Back	←≡≡≡≡

LUCKY 7 CLASSIC – Murfreesboro, TN

Show Date: May 2, 2025

SHOWMANSHIP

Youth 14-18 / Amateur / Select Amateur

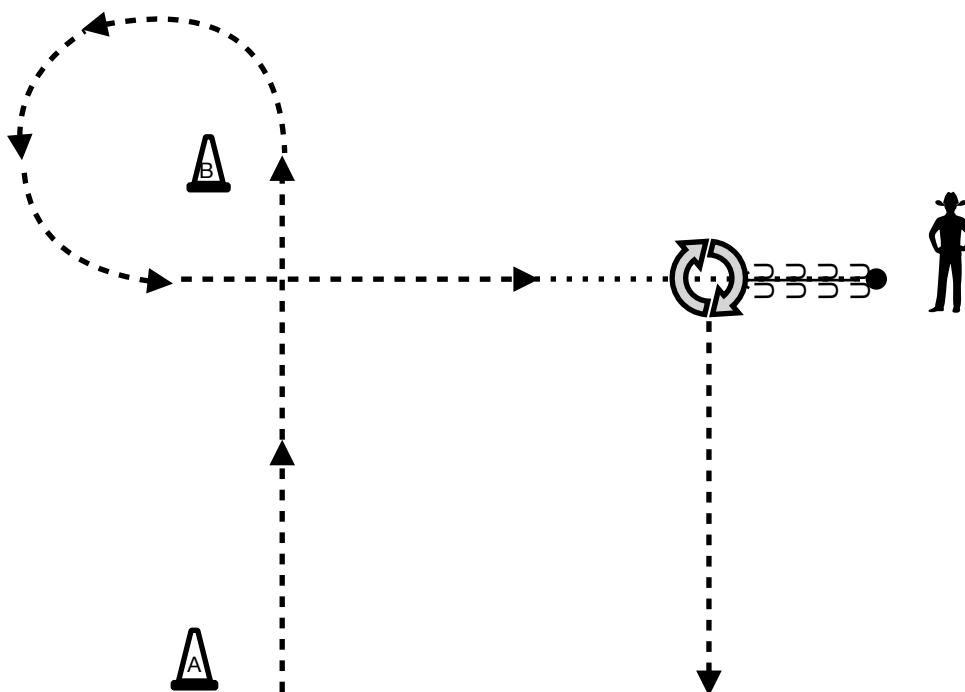

1. Be Ready at Cone A. Trot to & around B & halfway to the judge.
2. Walk to the judge.
3. Stop & Set up.
4. Inspection.
5. When dismissed, Back one horse length.
6. Perform a 45° turn.
7. Trot away.



Walk
Trot	-----
Back	← 3333

LUCKY 7 CLASSIC – Murfreesboro, TN
 Show Date: May 2, 2025

HORSEMANSHIP

**Non Pro L1
 L1 Youth
 L1 Amateur**

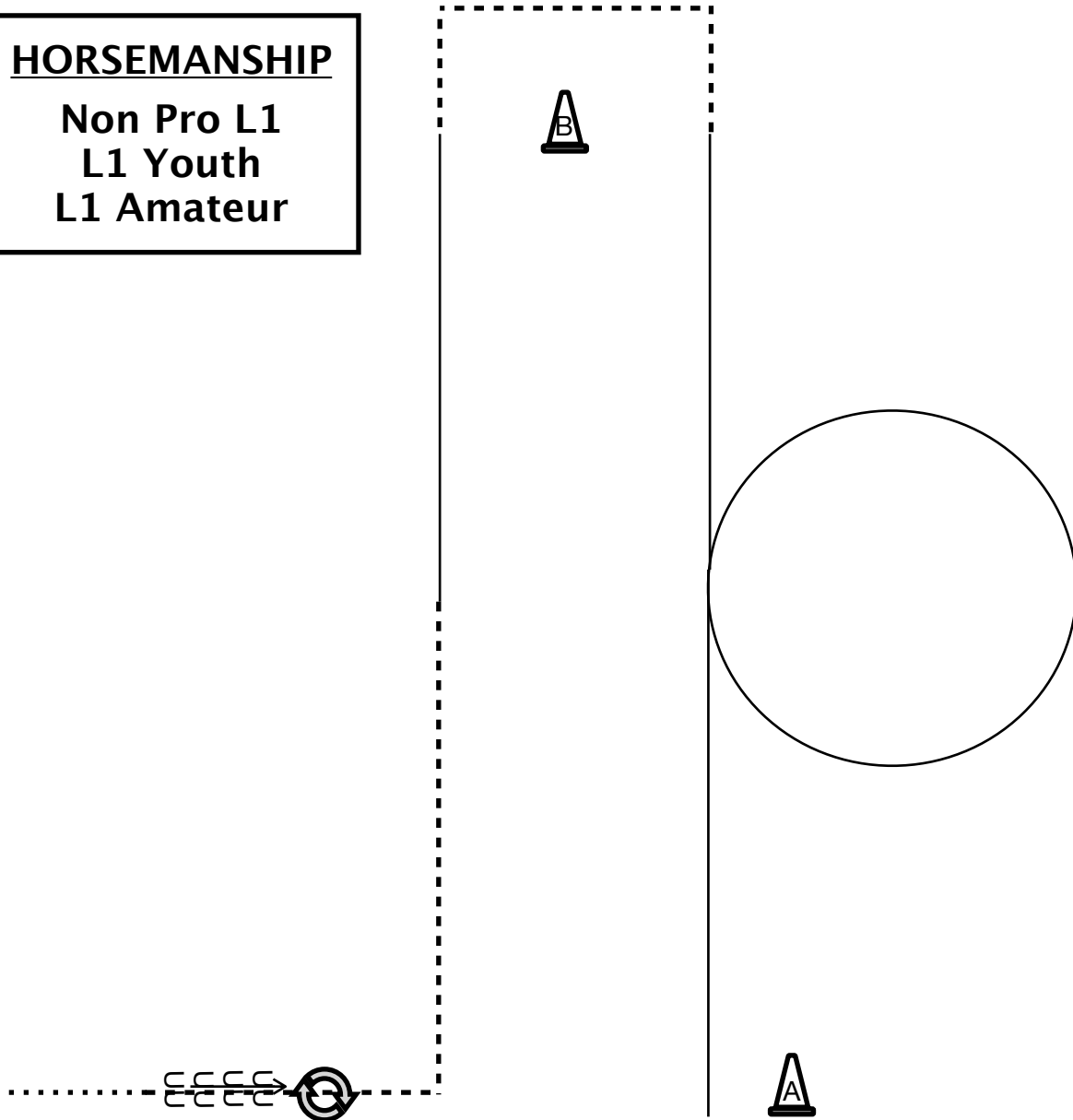

1. Lope right lead halfway to B and circle to the right, continue to B.
2. At B break to jog, jog square corners around B.
3. Lope left lead halfway to A.
4. Break to the jog, jog square corner.
5. Stop & Back.
6. Execute a 360° to the right.
7. Exit at a **walk**.



Walk
Jog	-----
Extended Trot	- - - -
Lope	_____
Lope w/ Speed	————
Back	←←←←←

LUCKY 7 CLASSIC - Murfreesboro, TN

Show Date: May 2, 2025

HORSEMANSHIP
Youth
Select Amateur
Amateur

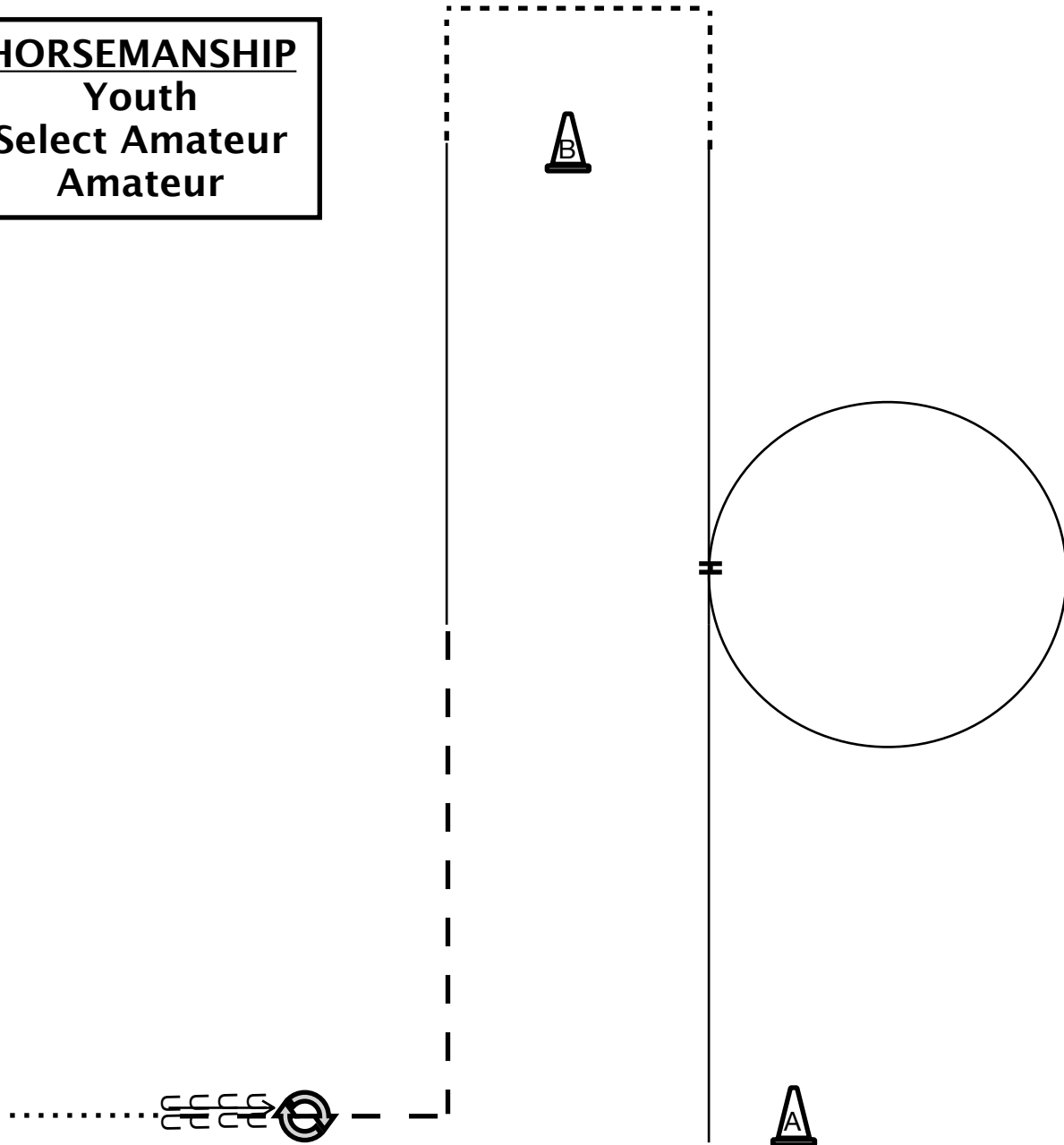

1. Lope left lead halfway to B.
2. Change Leads.
3. Lope right lead circle to the right, continue loping to B.
4. At B break to jog, jog square corners around B.
5. Lope left lead halfway to A.
6. Break to extended jog, Extend jog square corner.
7. Stop & Back.
8. Perform a 360° to the right.
9. Exit at a **walk**.



Walk
Jog	-----
Extended Trot	-----
Lope	_____
Lope w/ Speed	=====
Back	<<<<<<
Lead Change	I

LUCKY 7 CLASSIC – Murfreesboro, TN

Show Date: May 2, 2025

HORSEMANSHIP

Small Fry
L1 Am W/T
L1 Youth W/T

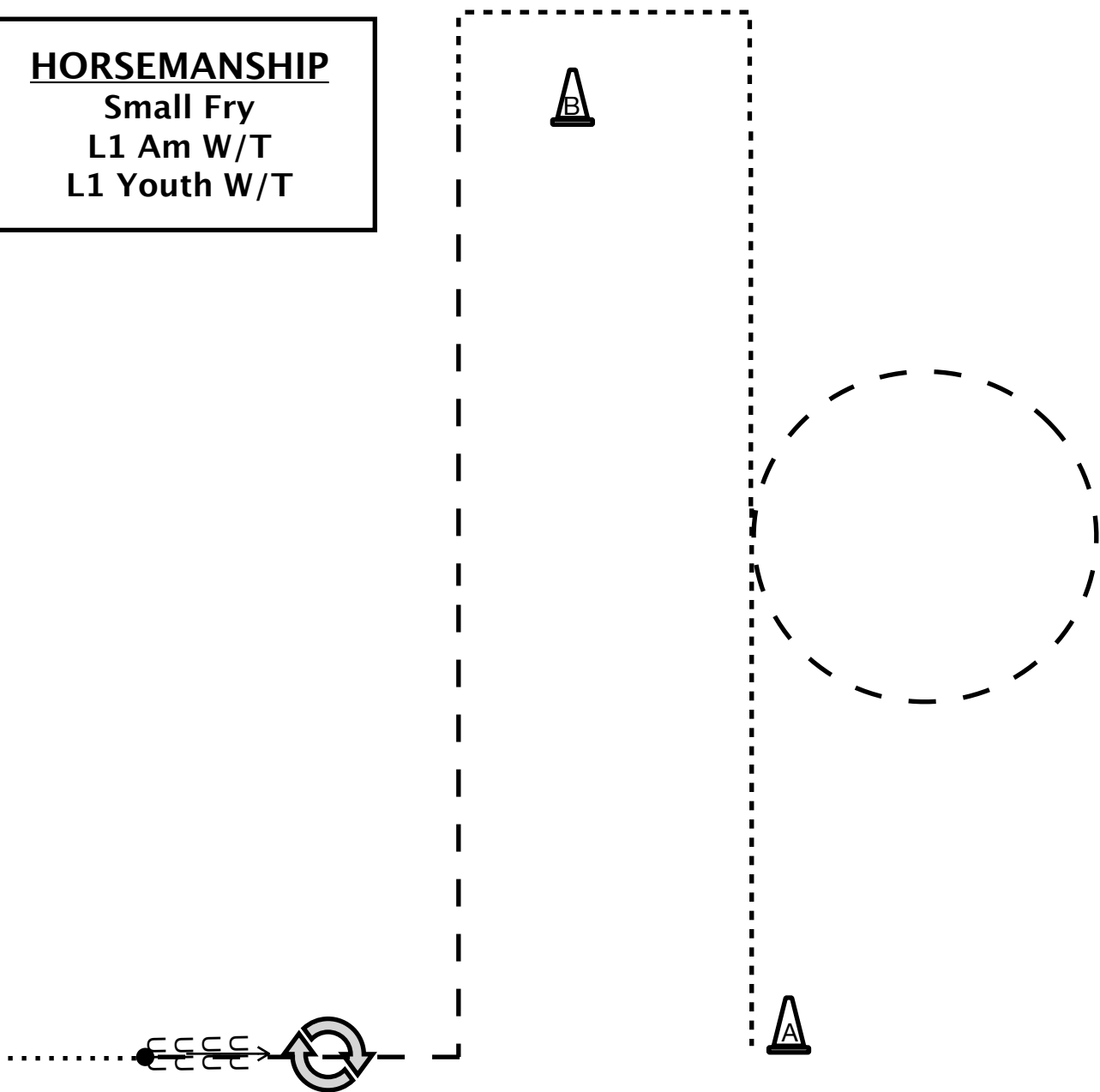

1. Jog halfway to B.
2. Extend jog in a circle to the right.
3. Close circle and collect jog and continue to jog a square corner around B.
4. Extend jog to A & make a square corner.
5. Stop and Back one horse length.
6. Turn 360° to the right.
7. Exit at a **walk**.



Walk
Jog	-----
Extended Trot	-----
Back	←3333

Lucky 7 Ranch Trail May 2, 2025

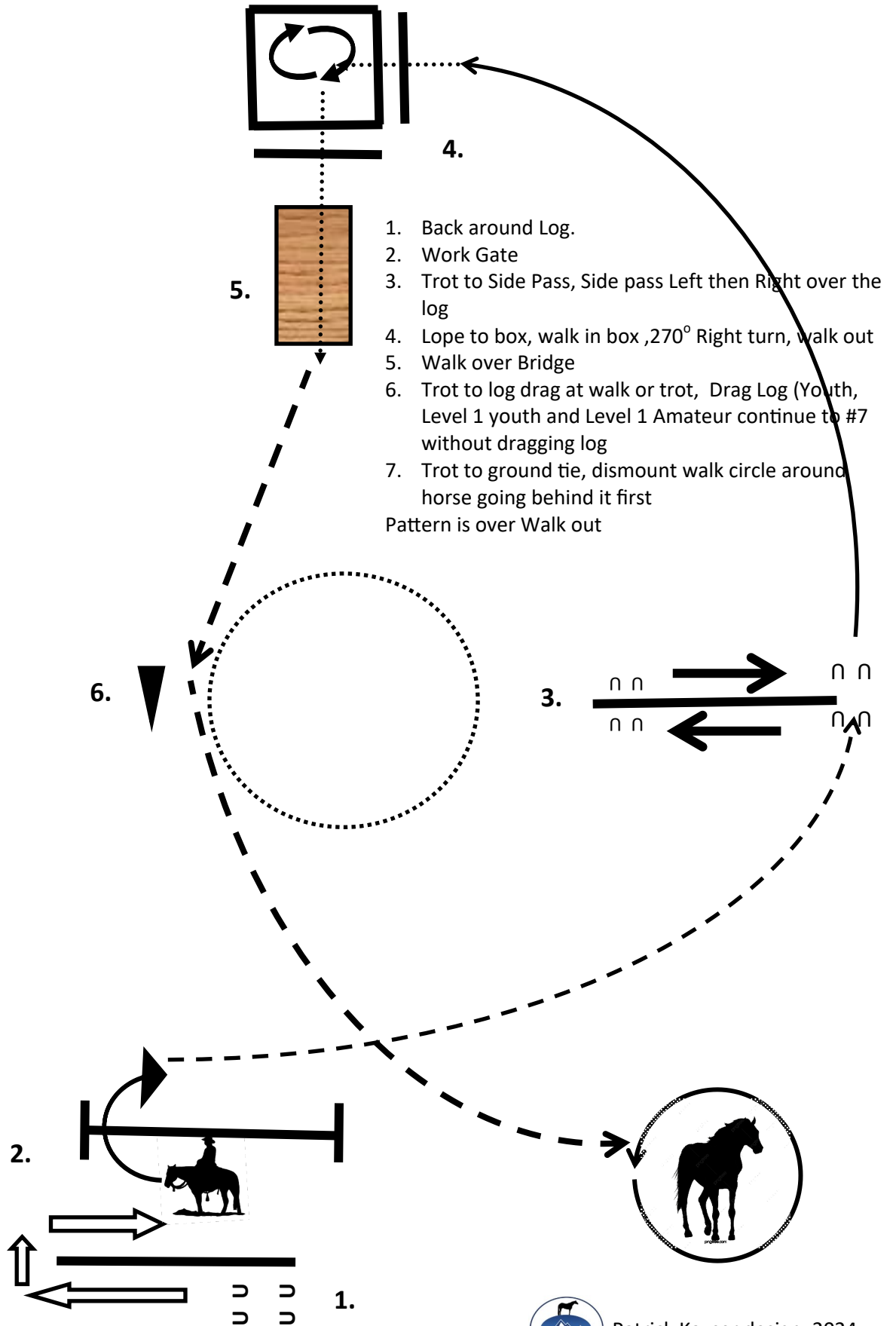

LUCKY 7 CLASSIC

All English Versatility - Pattern 5

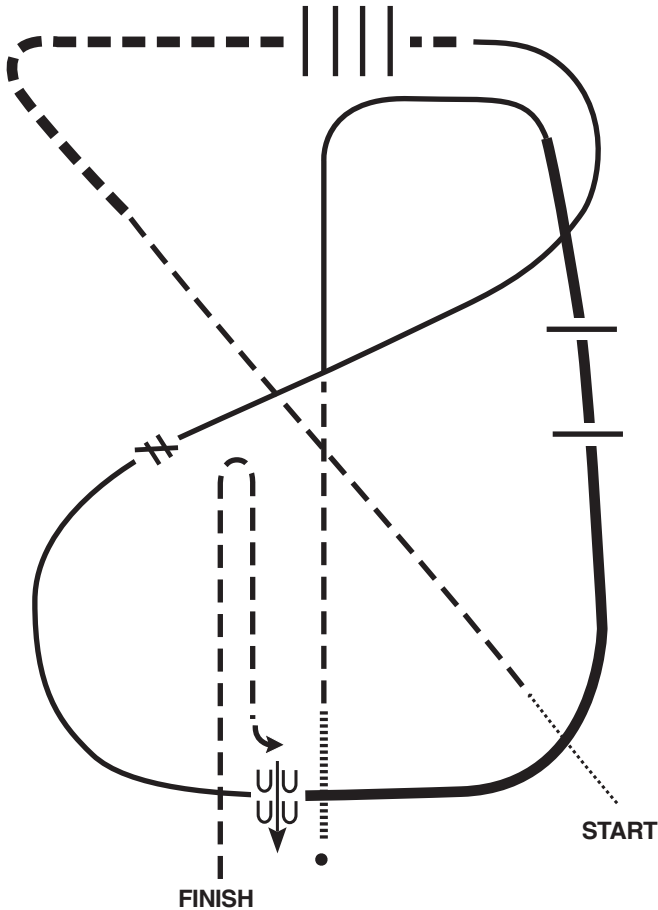

1. Forward Walk from Gate
2. Trot Diagonal Line Building to Extended Trot
3. Extended trot
4. Extended Trot over Four Poles
5. Collect Trot and Canter Right Lead Around top
6. Right Lead Diagonal Line and Change Leads (Simple or Flying)
7. Left Lead Canter Building to Hand Gallop at center
8. Hand Gallop over two Rails, Cavalletis or Small Jumps
9. Collect and Canter Down Center
10. Sitting Trot Down Center Line
11. Walk
12. Halt and Back
13. Forehand Turn Right
14. Trot to Exit

Walk
Jog/Trot	- - - - -
Lope/Canter	
Hand Gallop	
Extended Trot	
Leg Yield	
Change Lead	≠
Gate	
Back	←←←
Judge	⊙
Marker	○
Sidepass	←←←

LUCKY 7 CLASSIC
Working Hunter Over Fences Classes
Saturday May 3, 2025

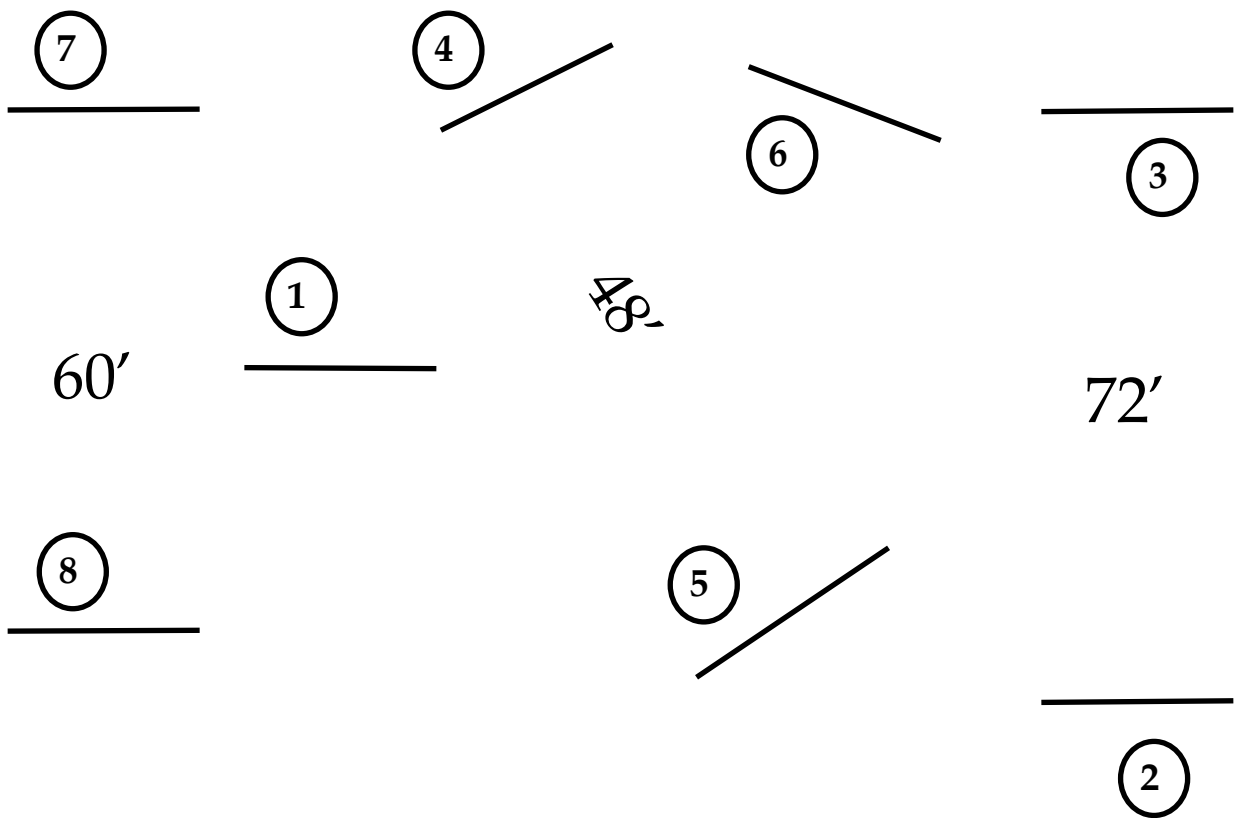

GATE

LUCKY 7 CLASSIC
Equitation Over Fences Classes
Saturday May 3, 2025

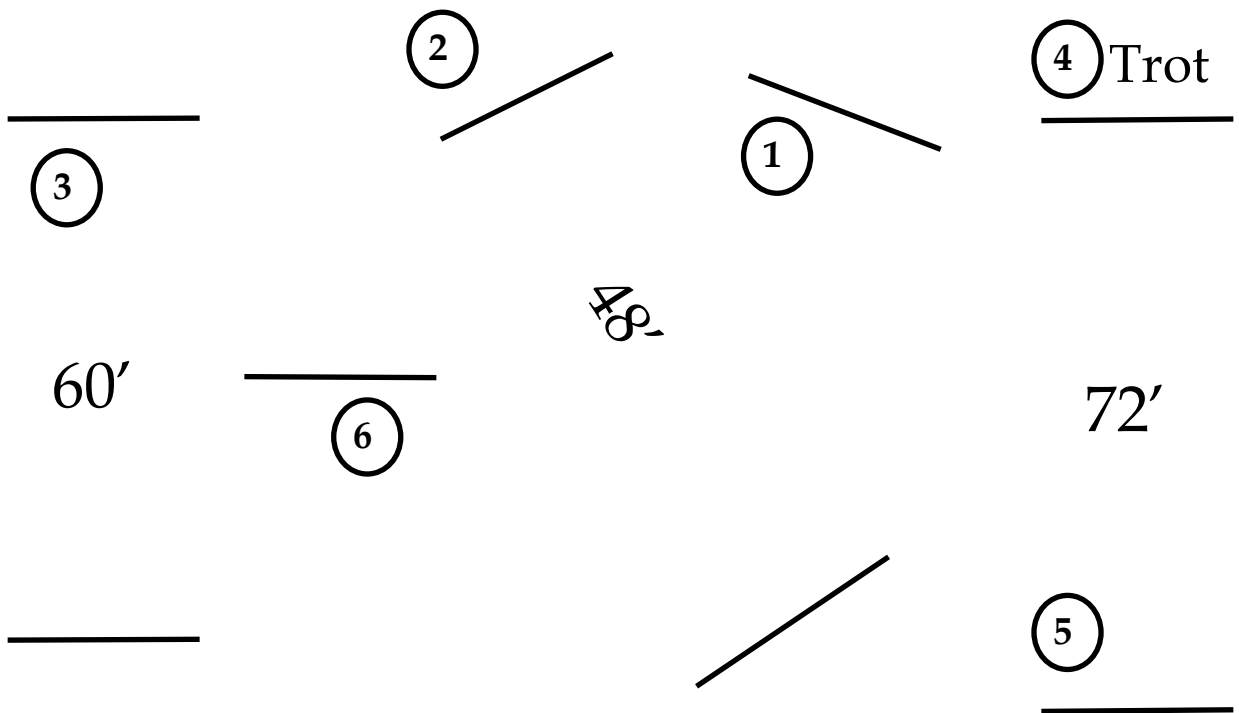

GATE

LUCKY 7 CLASSIC

Jumping Classes
Saturday May 3, 2025
Jump Off: 8, 2, 5, 6, 7, 1

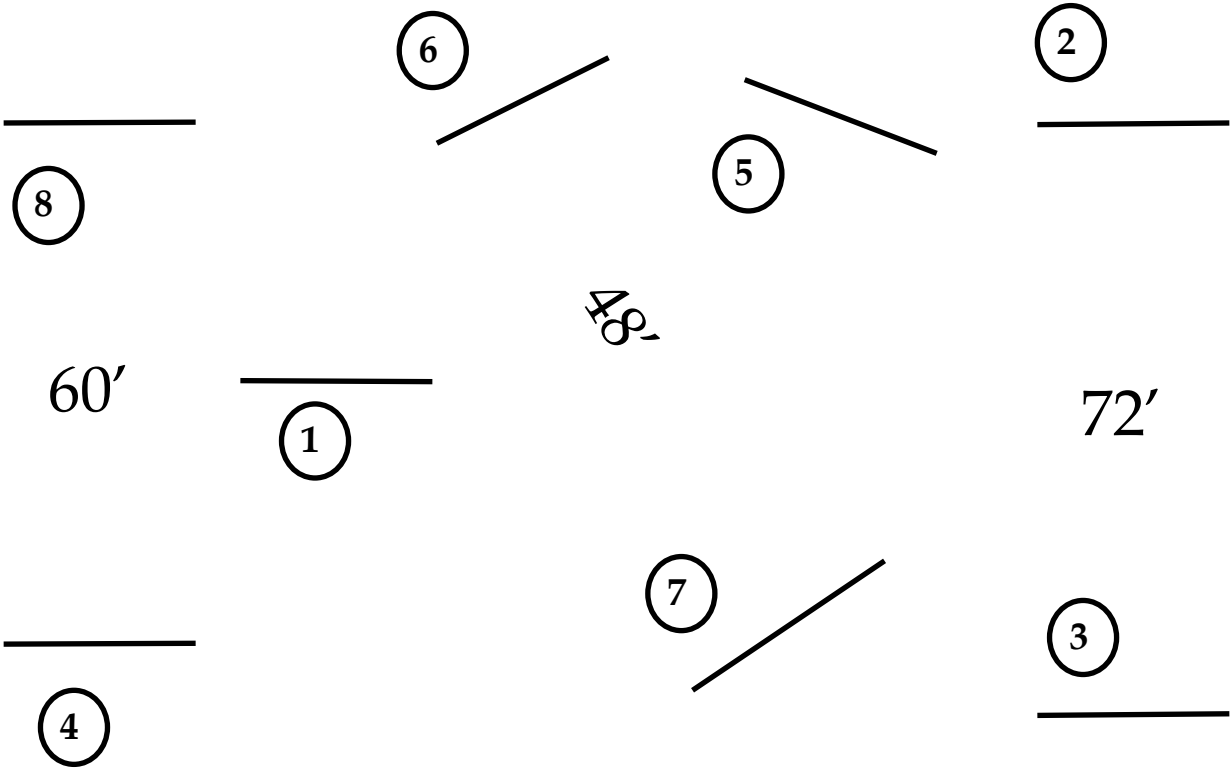

GATE

LUCKY 7 CLASSIC

Hunter Hack
Saturday May3, 2025

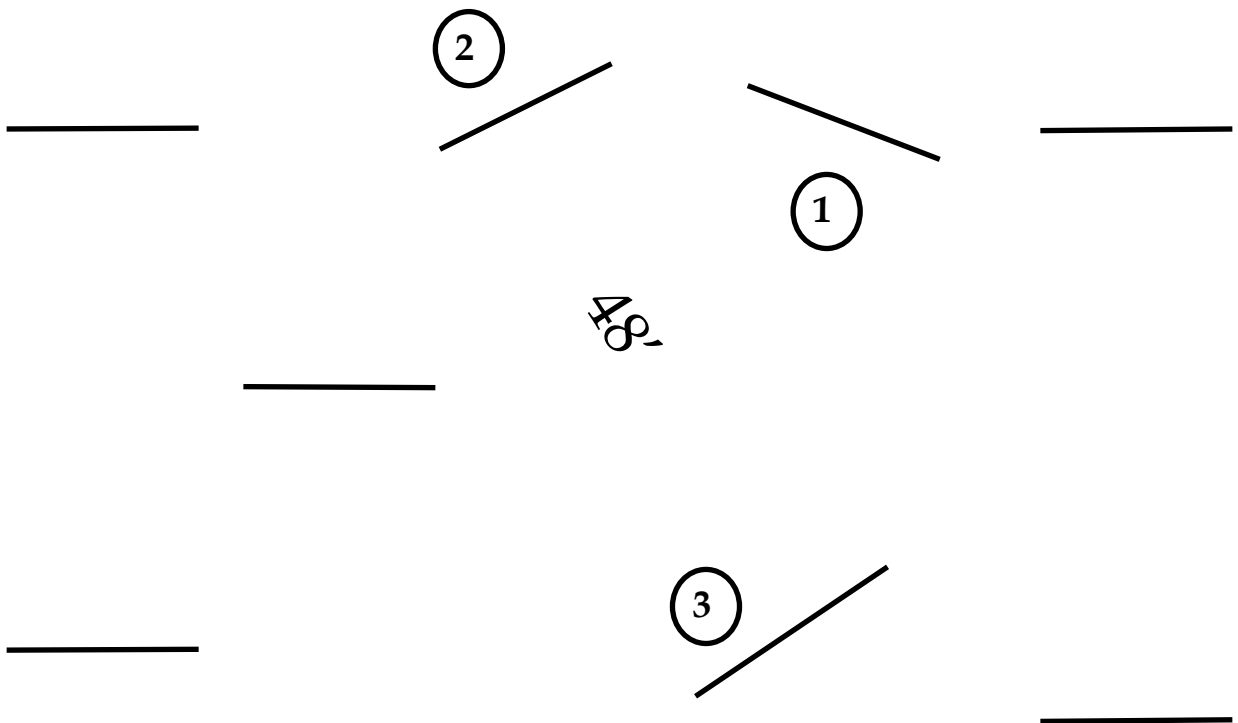

GATE

Lucky 7 Classic

All HuntSeat Equitation Walk/Trot Classes

Show Date: 05/03/2025

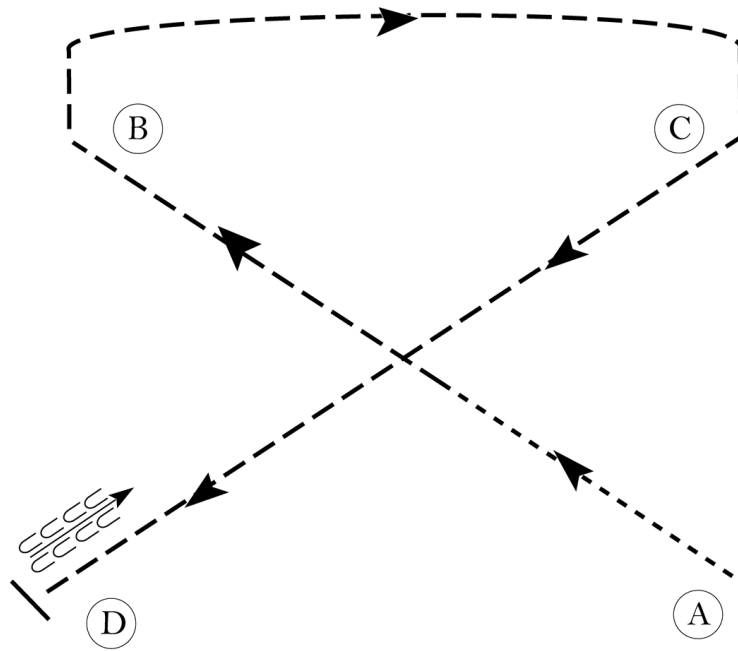

Be ready at A.

1. Walk 1/2 way to B.
2. Posting trot on the left diagonal to B.
3. Sitting trot to C.
4. Posting trot on the right diagonal to D.
5. Halt at D and back approximately one horse length.

Exit at a sitting trot.

Walk	-----
Trot	- - - - -
Extended Trot	— — — —
Canter	—————
Leg Yield	
Lead Change	— / —
Back	←←←←← ←←←←←
Marker	(B)
Sidepass	← — — — ←
Hand Gallop	— — — —

[HSE/WT-24]

Pattern Provided by:

Kerry Allen

Lucky 7 Classic

Hunt Seat Equitation (Novice Youth, Novice Amateur)

Show Date: 05/03/2025

www.HorseShowPatterns.com

www.HorseShowPatterns.com

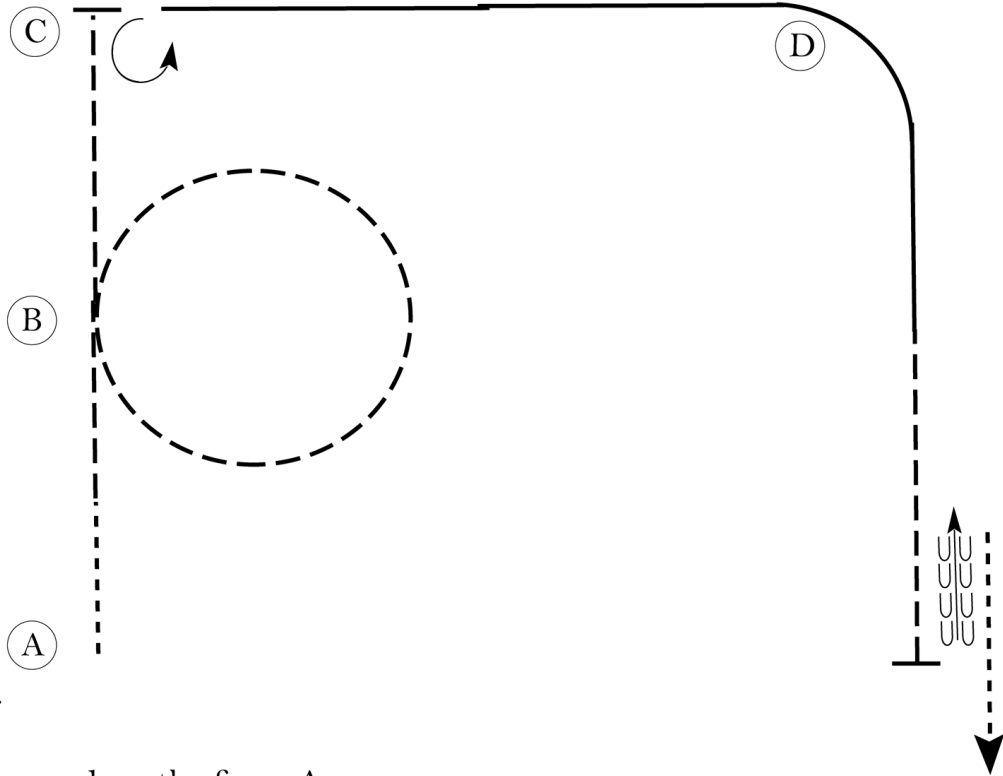

Be ready at A.

1. Walk two horse lengths from A.
2. Sitting trot to B.
3. At B, trot a circle to the right on the left diagonal.
4. Continue trot to C.
5. Stop at C and perform a 270 degree turn on the hindquarters to the left.
6. Canter on the right lead to and around D.
7. When even with B, begin a posting trot on the right diagonal.
8. Stop when even with A and back approximately one horse length.

Walk away from D and follow the instructions of your ring steward.

Walk	-----
Trot	- - - - -
Extended Trot	-----
Canter	—————
Leg Yield	
Lead Change	↘ ↙
Back	← ← ← ← ←
Marker	(B)
Sidepass	← — — — — →
Hand Gallop	—————

[HSE/2-44]

Pattern Provided by:

Kerry Allen

Lucky 7 Classic

Hunt Seat Equitation (Amateur, Select and 14-18, 13 & Under)

Show Date: 05/03/2025

www.HorseShowPatterns.com

www.HorseShowPatterns.com

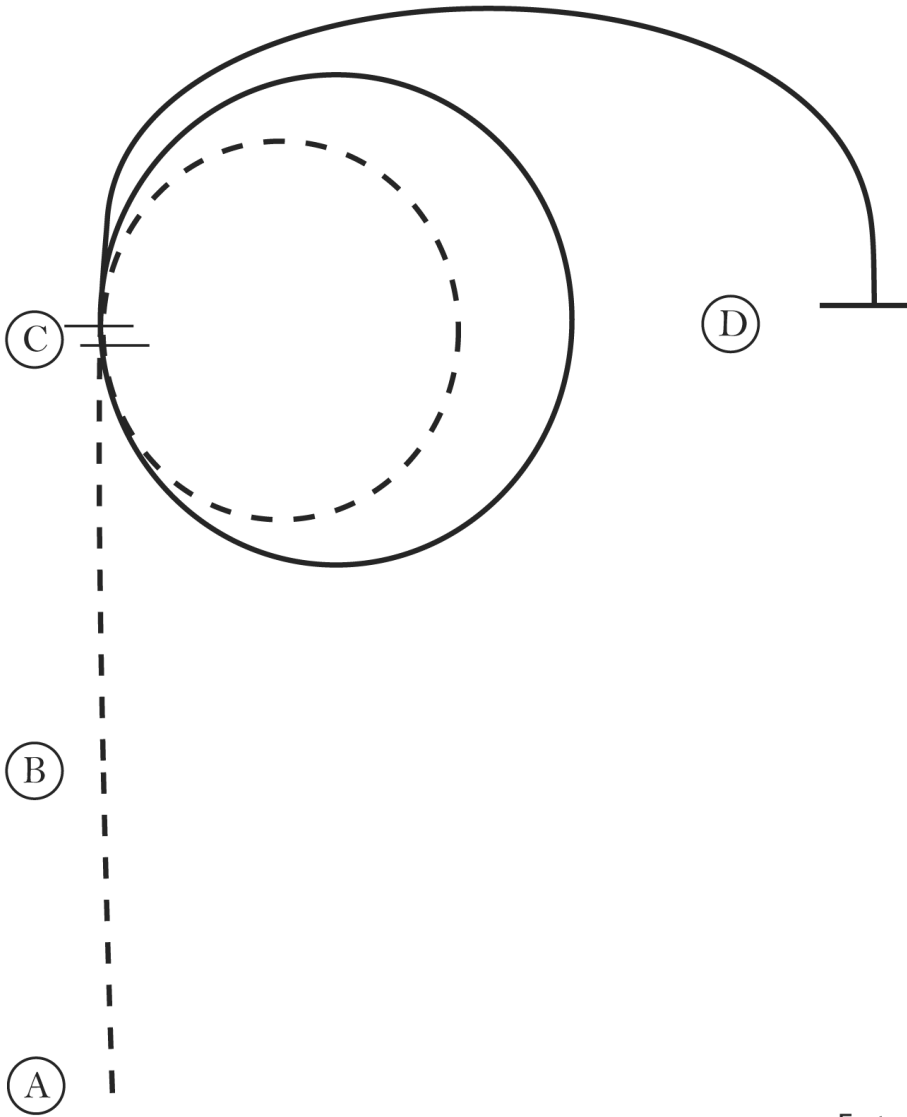

1. Sitting trot A to B
2. At B posting trot to C on the right diagonal
3. At C posting trot circle to the right on the left diagonal
4. At C canter a circle to the right on the right lead
5. At C perform a lead change and canter around to D
6. Stop at D

Walk
Trot	-----
Extended Trot	-----
Canter	—————
Leg Yield	
Lead Change	↘
Back	←←←←←
Marker	⊙ (B)
Sidepass	←-----←

[HSE/3-10]

Pattern Provided by:

Kerry Allen

ALL RANCH RIDING - PATTERN 3- MAY 3

LEGEND

.....	Walk
....	Extended Walk
- - -	Trot
- - -	Extended Trot
—	Lope
—	Extended Lope
////	Back
\\	Lead Change

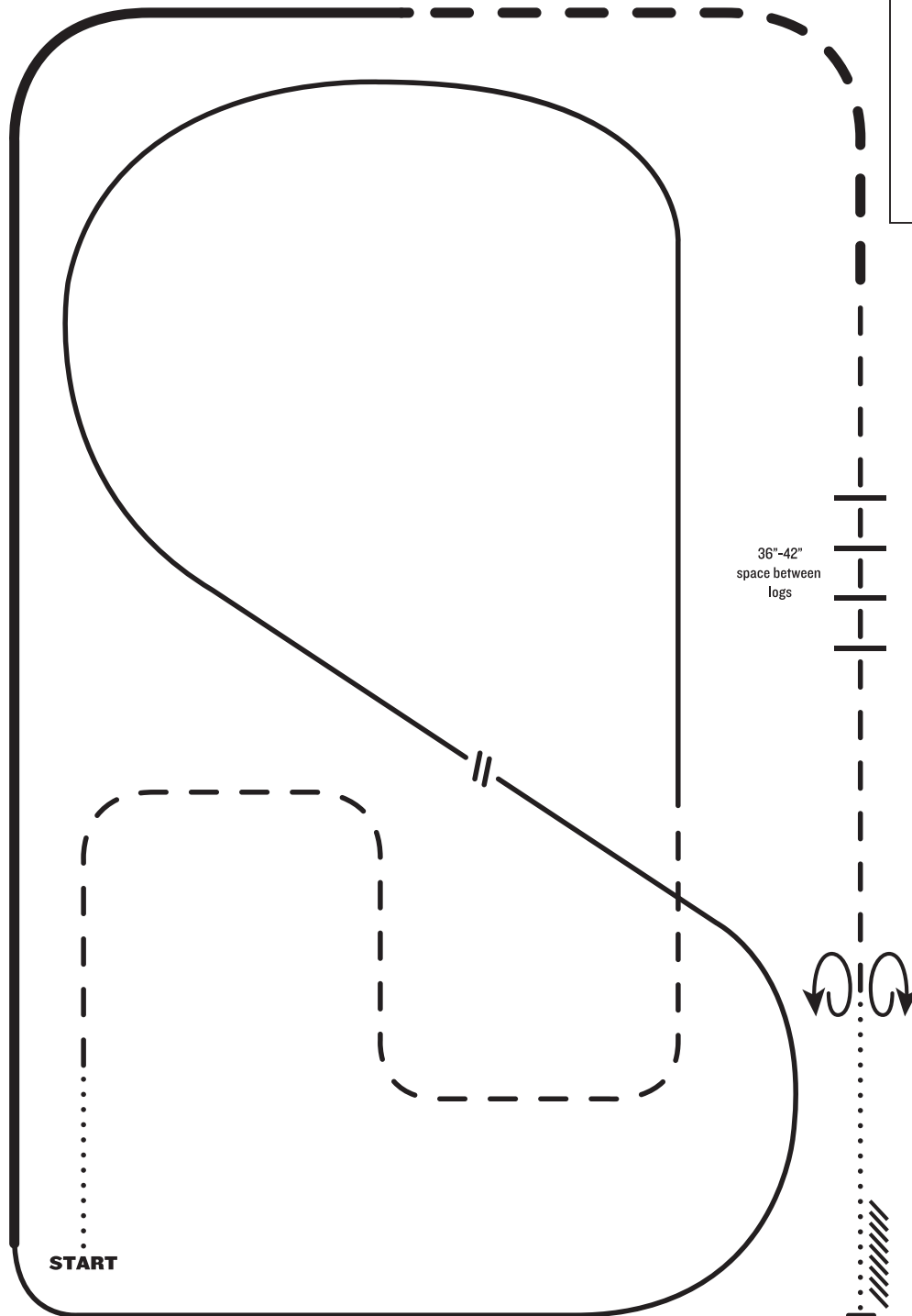

- I. Walk
2. Trot serpentine
3. Lope left lead around the end of the arena and then diagonally across the arena
4. Change leads (simple or flying)
5. Lope right lead around end of the arena
6. Extend lope on the straight away and around corner to the center of the arena
7. Extend trot around corner of the arena
8. Collect to a trot
9. Trot over logs
10. Stop, 360° turn each direction (either direction 1st) (L-R or R-L)
- II. Walk, stop and back

Note: The drawn description of this pattern is only intended for the general depiction of the pattern. Exhibitors should utilize the arena space to best exhibit their horses.

ALL REINING PATTERN 11-MAY 3

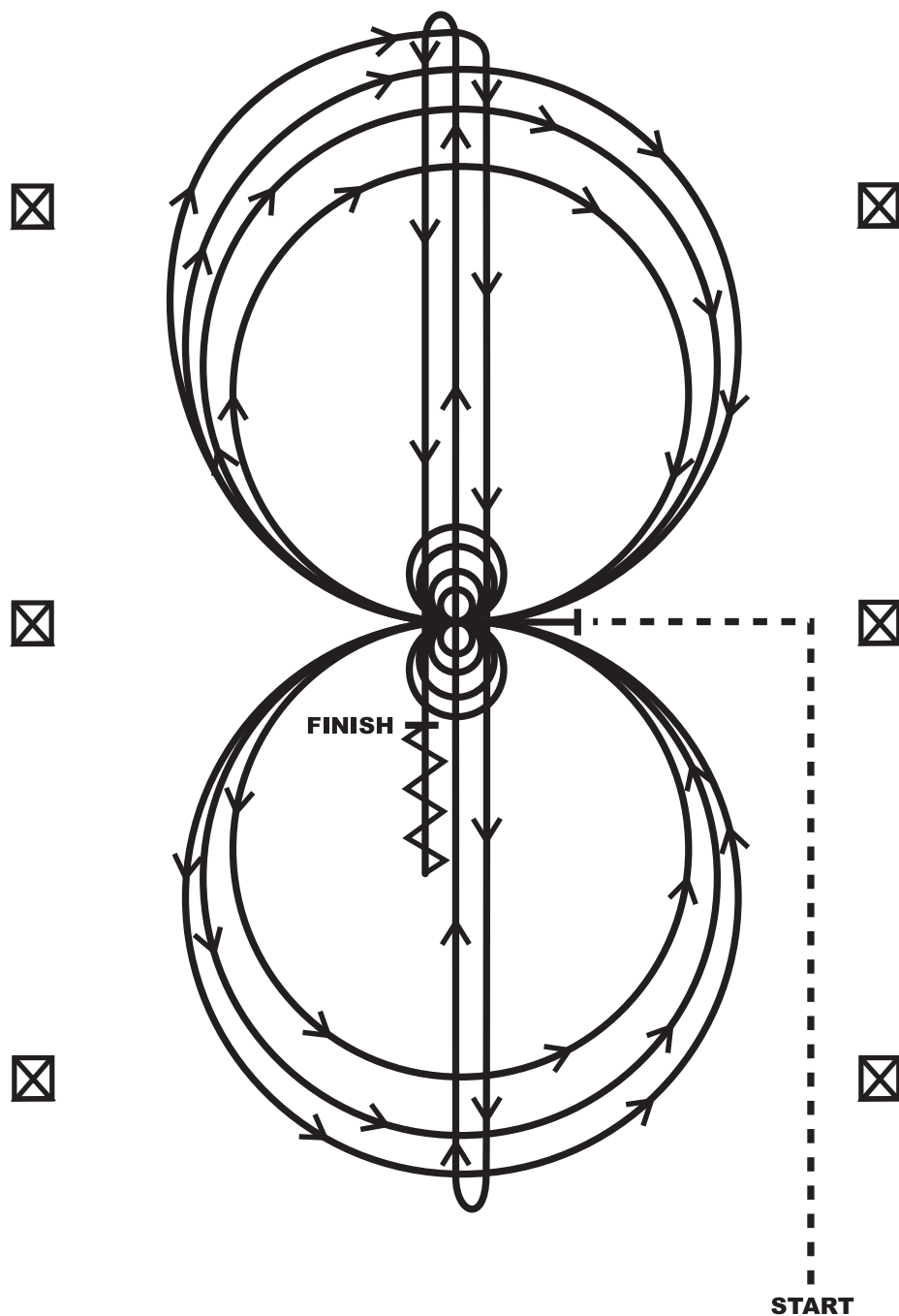

Horses must jog to the center of the arena. Horses must walk or stop prior to starting the pattern. Beginning at the center of the arena facing the left wall or fence.

1. Complete four spins to the left. Hesitate.
2. Complete four spins to the right. Hesitate.
3. Beginning on the right lead complete three circles to the right; the first circle small and slow; the next two circles large and fast. Change leads at the center of the arena.
4. Complete three circles to the left; the first circle small and slow; the next two circles large and fast. Change leads at the center of the arena.
5. Begin a large circle to the right, but do not close this circle. Run down the center of the arena past the end marker and do a right rollback—no hesitation.
6. Run up the middle to the opposite end of the arena past the end marker and do a left rollback—no hesitation.
7. Run past the center marker and do a sliding stop. Back up to the center of the arena or at least ten feet (three meters). Hesitate to demonstrate completion of the pattern.

May 4, 2025

LUCKY 7 CLASSIC - Murfreesboro, TN

ALL TRAIL (except Small Fry - W/T)

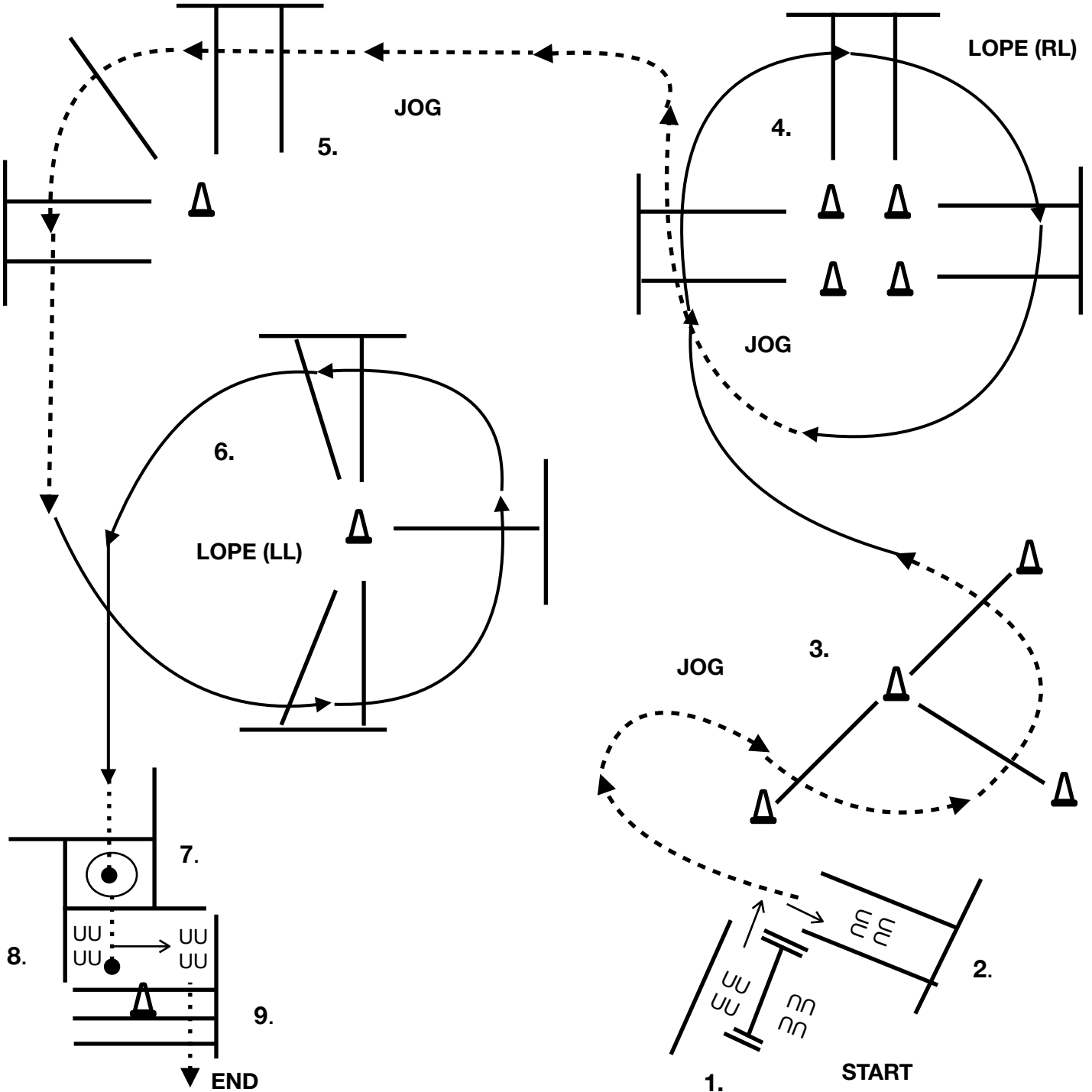

1. Work Left Hand Gate.
2. Back around corner into chute.
3. Jog out of chute and over poles as shown.
4. Lope Right Lead over 6 poles. Jog over 2 poles.
5. Jog over poles.
6. Lope Left Lead over poles.
7. Stop or Break to the walk. Walk into box. 360° turn either direction.
8. Walk out over pole. Side pass to the left.
9. Walk out over poles to end pattern.



WALK
JOG	-----
LOPE	_____

May 4, 2025

LUCKY 7 CLASSIC - Murfreesboro, TN

Small Fry - Yth W/T L1 - Am W/T L1

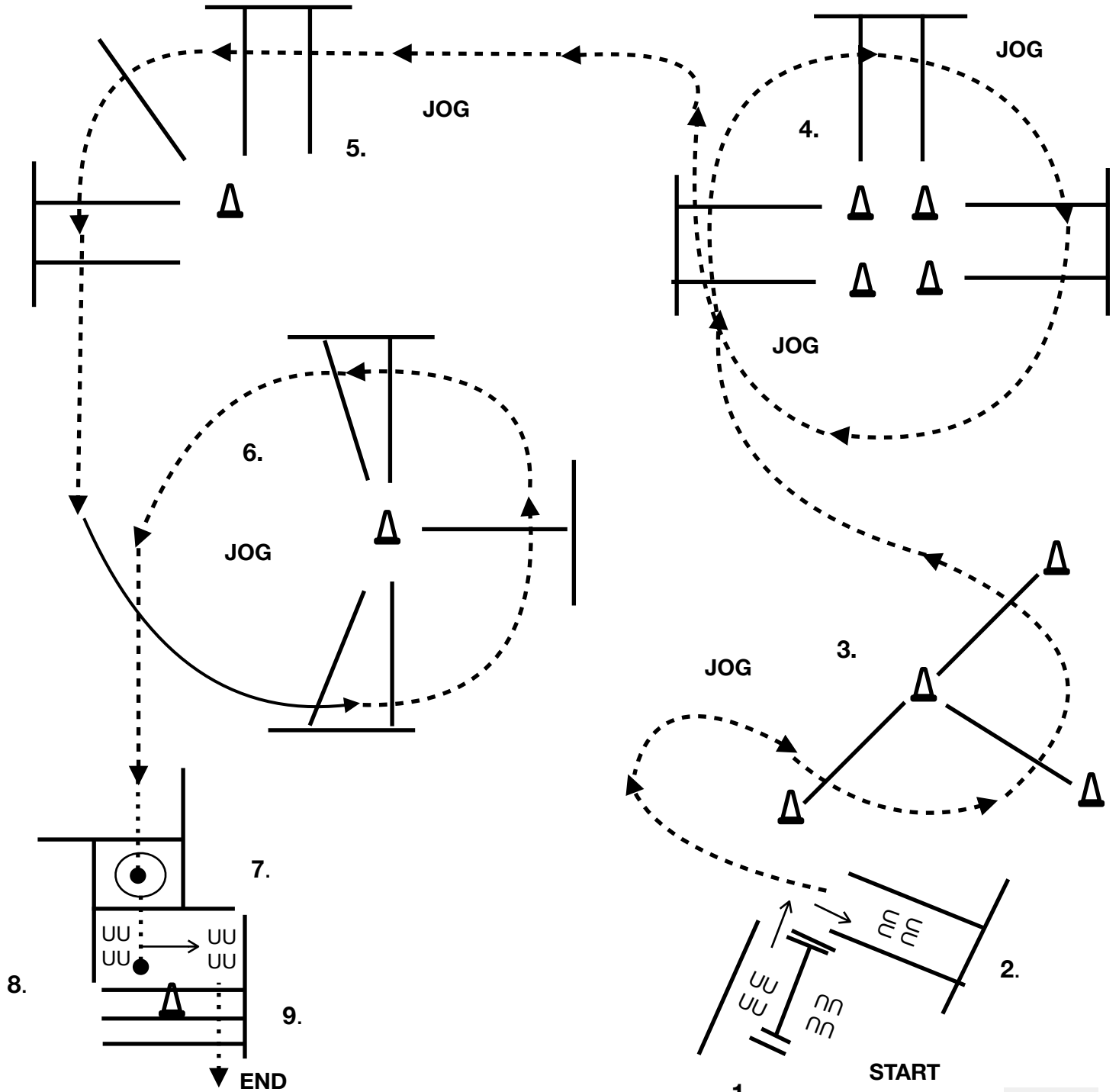

1. Work Left Hand Gate.
2. Back around corner into chute.
3. Jog out of chute and over poles as shown.
4. Jog over 8 poles.
5. Jog over poles.
6. Jog over poles.
7. Stop or Break to the walk. Walk into box. 360° turn either direction.
8. Walk out over pole. Side pass to the left.
9. Walk out over poles to end pattern.

patterns 2024
by
Christie

WALK
JOG	-----
LOPE	_____

ALL WESTERN RIDING - PATTERN 4-May 4

LEGEND

.....	Walk
- - -	Jog
————	Lope
///////	Back
■	Lead Changing Area

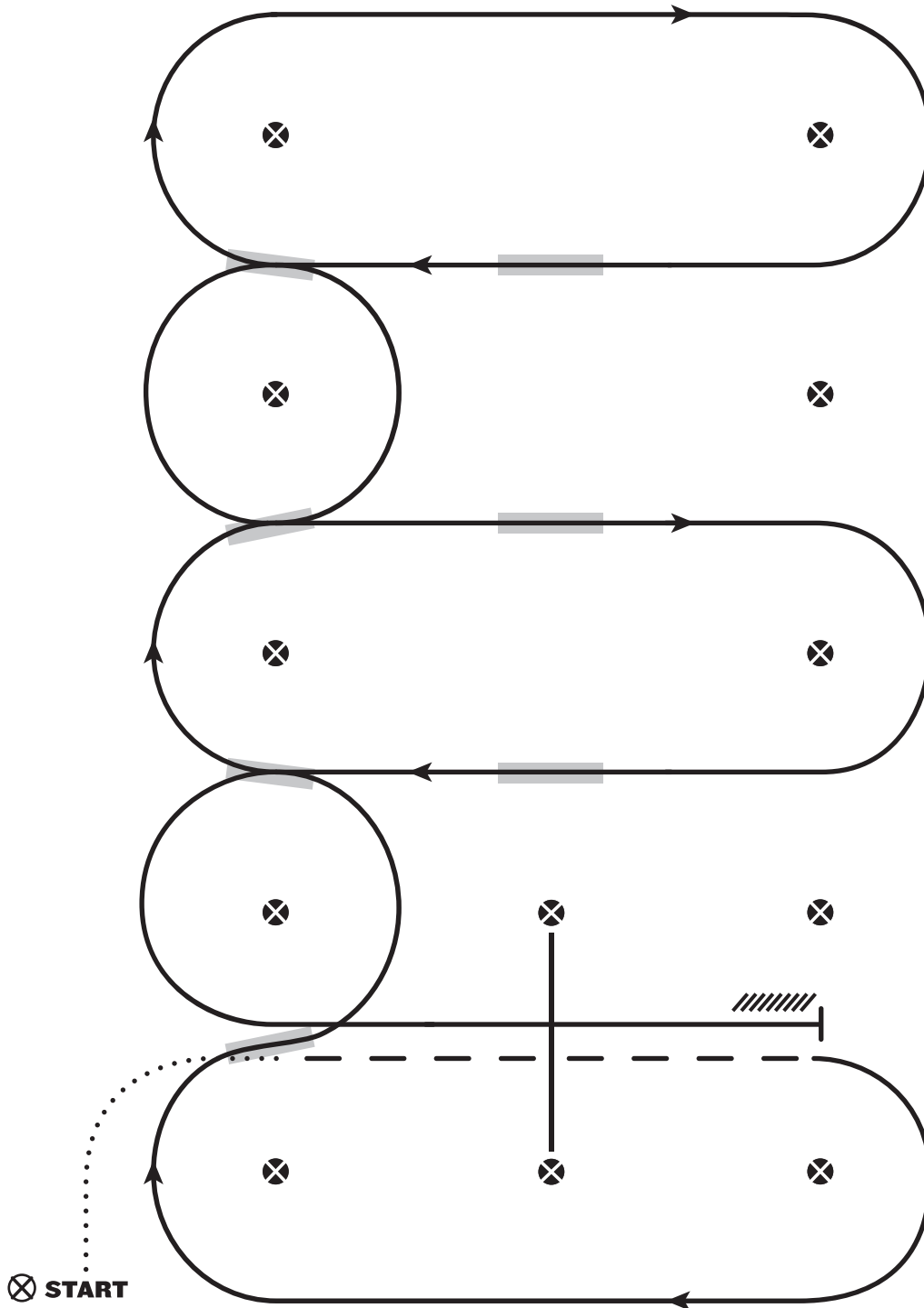

1. Walk at least 15 feet from start cone to the first marker, as drawn, transition to jog, jog over log.
2. Transition to the lope right lead
3. First line change
4. Second line change
5. Third line change
6. Fourth line change
7. First crossing change
8. Second crossing change
9. Third crossing change
10. Lope over log
11. Lope, stop & back

Lucky 7 Classic

All Walk/Trot Horsemanship classes

Show Date: 05/04/25

w w w . H o r s e S h o w P a t t e r n s . c o m

w w w . H o r s e S h o w P a t t e r n s . c o m

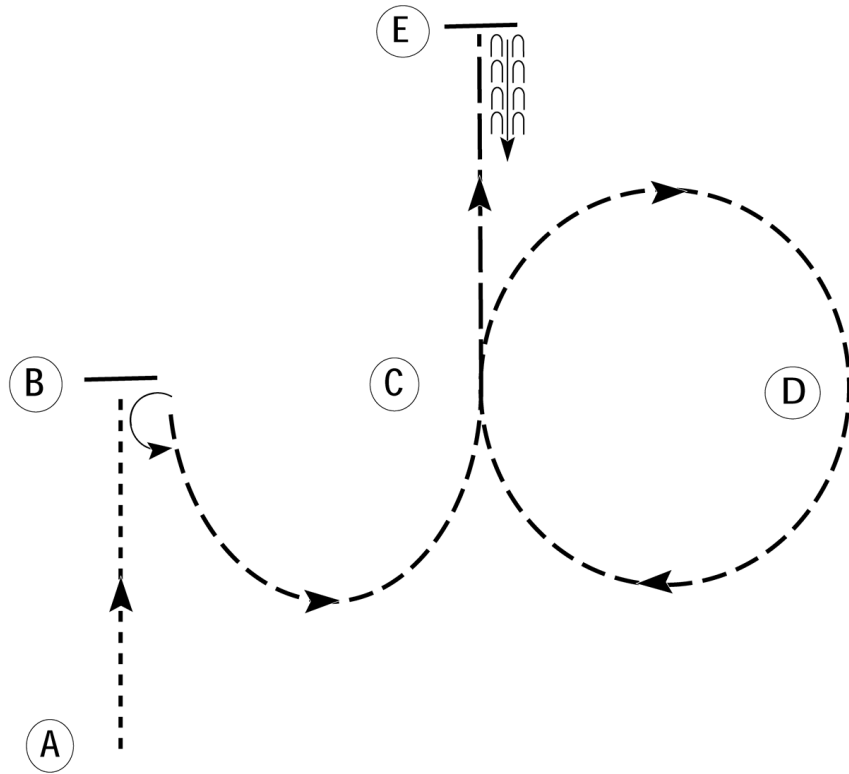

Be ready at A.

1. Walk to B.
2. Stop at B and turn 180 degrees to the left.
3. Jog to C..
4. Jog a circle to the right.
5. Extend the jog to E.
6. Stop at E and back approximately one horse length.

Follow the instructions of your ring steward.

Walk	-----
Jog	- - - - -
Extended Jog	- - - - -
Lope	—————
Leg Yield	
Lead Change	— / —
Back	← U U U U U
Marker	Ⓟ
Sidepass	← — — — — →

[WH/WT-61]

Pattern Provided by:

Kerry Allen

Lucky 7 Classic

Western Horsemanship (Novice Youth, Novice Amateur)

Show Date: 05/04/2025

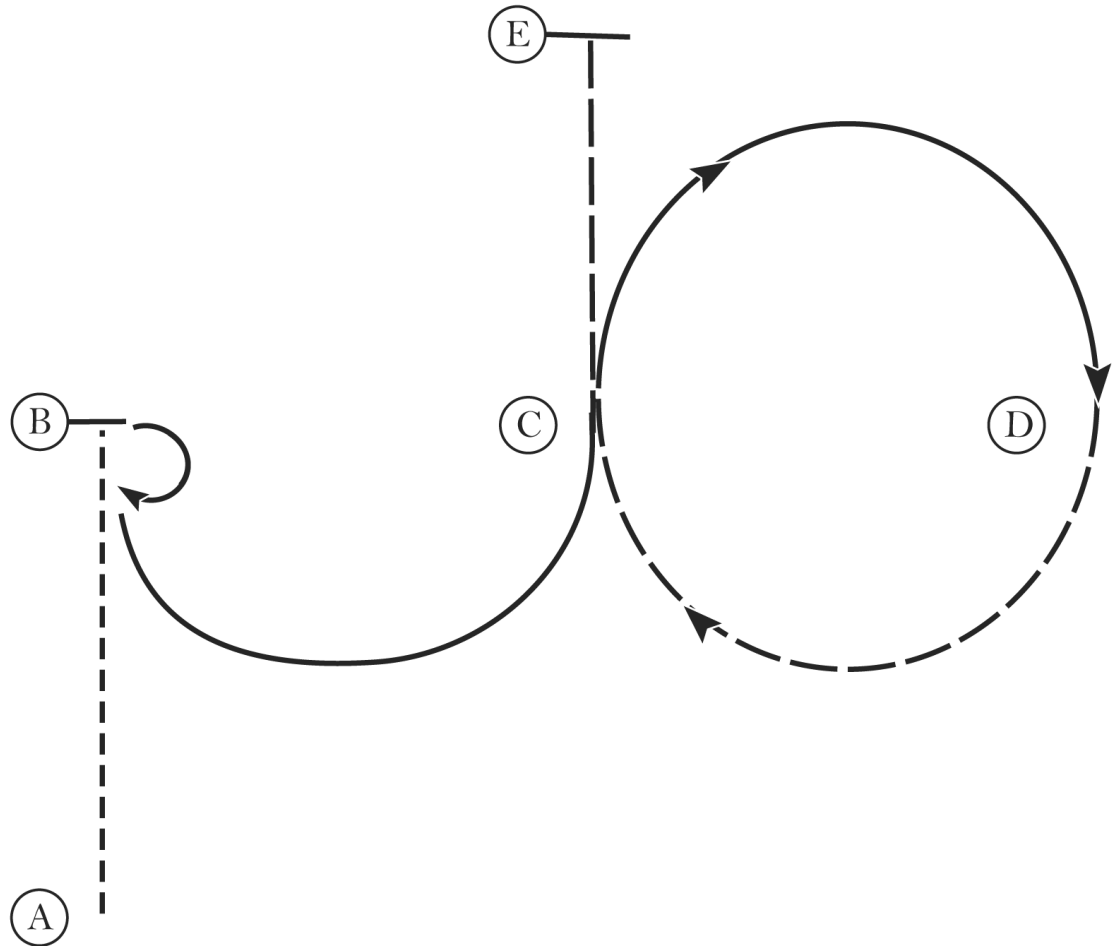

1. Jog A to B,
2. At B stop and perform a 180 degree turn to the right.
3. Lope on the right lead in a half circle to C.
4. At C maintain the right lead in a half circle to D.
5. At D extend the jog in a half circle to C and continue to E.
6. At E stop.

Walk
Jog	-----
Extended Jog	- - - - -
Lope	—————
Leg Yield	
Lead Change	↘
Back	←←←←←
Marker	(B)
Sidepass	←←←←←

[WH/2-4]

Pattern Provided by:

Kerry Allen

Lucky 7 Classic

Western Horsemanship (Amateur, Select, 14-18, 13 & Under)

Show Date: 05/04/2025

w w w . H o r s e S h o w P a t t e r n s . c o m

w w w . H o r s e S h o w P a t t e r n s . c o m

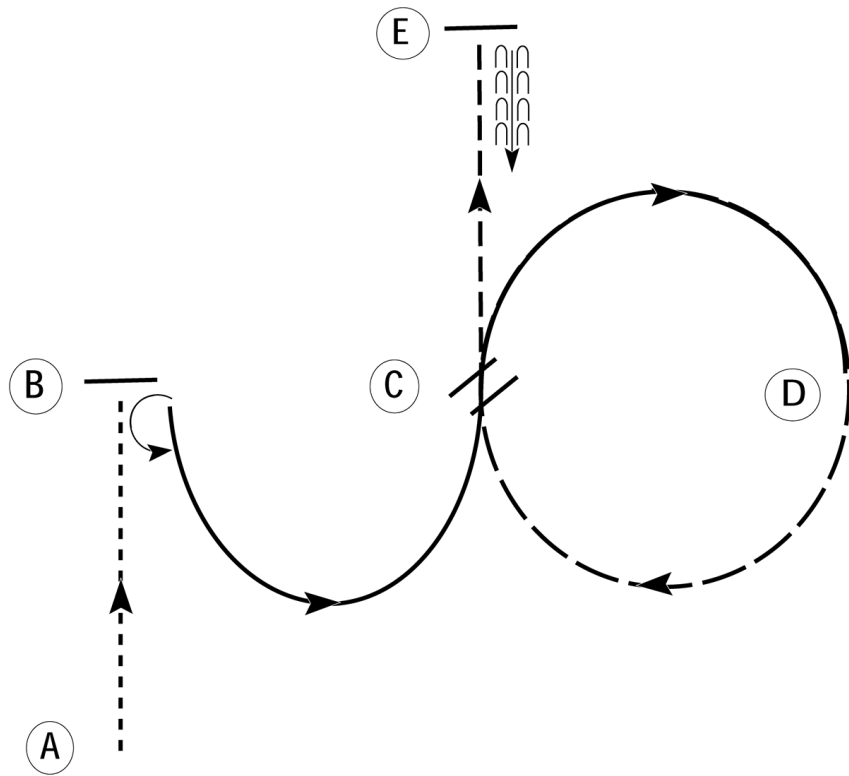

Be ready at A.

1. Walk to B.
2. Stop at B and turn 180 degrees to the left.
3. Lope on the left lead to C.
4. Perform a flying lead change at C.
5. Lope on the right lead to D.
6. Extend the jog to C.
7. Jog to E. Stop and back approximately one horse length.

Follow the instructions of your ring steward.

Walk	-----
Jog	- - - - -
Extended Jog	- - - - -
Lope	—————
Leg Yield	
Lead Change	— / —
Back	← ← ← ← ←
Marker	Ⓚ
Sidepass	← ← ← ← ←

[WH/3-61]

Pattern Provided by:

Kerry Allen